

INSTALLER:

Leave this manual with the appliance.

CONSUMER:

Retain this manual for future reference.

WARNING: If the information in these instructions is not followed exactly a fire or explosion may result causing property damage, personal injury or death.

FOR YOUR SAFETY

Do not store or use gasoline or other flammable vapours and liquids in the vicinity of this or any other appliance.

WHAT TO DO IF YOU SMELL GAS

- Do not try to light any appliance.
- Do not touch any electrical switch.
- Do not use any phone in your building.
- Immediately call your gas supplier from a neighbour's phone. Follow the gas supplier's instructions.
- If you cannot reach your gas supplier call the fire department.

Installation and service must be performed by a qualified installer, service agency or the gas supplier.

This appliance is suitable for installation in a bedroom or bed sitting room.

This appliance is only for use with the type of gas indicated on the rating plate. This appliance is not convertible for use with other gases unless a certified kit is used.



Gas Safety
Certified

AS/NZS 5263.1.3
SAI-400322

This appliance is certified for use in Australia with Natural Gas and Liquid Propane Gas.

This appliance is certified for use in New Zealand with Natural Gas only.

**PACIFIC
ENERGY**

SERIAL #

**MIRAGE 18
INSTALLATION AND
OPERATING INSTRUCTIONS**



**MODEL: MIRAGE 18, SERIES: A
BALANCED FLUE FREE STANDING
GAS HEATER**

Table of Contents

Caution	3	Flue Components	21
Safety	4	Gas and Electrical Connections	21
Warnings and Cautions	5	Gas Supply	22
Operating Instructions	7	Gas Pressure Testing Procedure	23
First Fire	8	Firebox Panel Removal / Installation	24
Special Operator Note	8	Removal	24
Remote Control Operation	8	Burner Kit/Media Installation/Removal	25
Remote Transmitter Description	10	Installation	25
Transmitter (Remote Control with LCD Display)	10	Removal	25
IFC Module	10	Optional Glass Media Installation	26
Initializing the Fireplace for the first time	10	Optional Log Media Installation	27
Temperature indication Display	11	Log Placement	27
Turn on the Stove	11	Door Removal / Installation	28
Turn off the Stove	11	Battery Installation	29
Manual Bypass of the Remote Control Transmitter	11	Air Adjustment	30
Remote Flame Control	11	Pilot Adjustment	31
Room Thermostat (Transmitter Operation)	12	Comfort Fan Removal / Installation	32
Smart Thermostat (Transmitter Operation)	12	Exterior Panel Removal/Installation	33
Comfort Fan Speed Control	12	Removal	33
Continuous Pilot/Intermittent Pilot (CPI/IPI) selection	13	Installation	34
Key Lock	13	Pilot Assembly Replacement	35
Low Battery Power Detection	13	To access and remove the pilot assembly.	35
Receiver	13	Replacing the pilot assembly.	37
Lighting Instructions	14	Propane Conversion	39
Installing the Mirage 18	15	Maintenance	40
Installation Checklist	15	Glass Door:	40
Mirage 18 Dimensions	16	Annual Inspection:	40
Locating the Stove	17	Periodically	40
Clearances to Combustibles	18	Replacement Parts	41
Flue Terminal Minimum Clearances	19	Wiring Diagram	42
Co-axial Flueing	20	Rating Label	43

LISTINGS AND CODE APPROVALS

These gas appliances have been tested in accordance with AS/NZS 5263.0:2017 and AS/NZS 5263.1.3 and have been certified by SAI GLOBAL Limited for installation and operation as described in these Installation and Operating Instructions. Must be installed as per AS/NZS 5601.1. Your unit should be serviced annually by an authorized service person.

AS/NZS 5601.1:2013 contains the requirements and methods of compliance for the “design, installation and commissioning of gas installations that are associated with the use or intended use of fuel gases such as natural gas, LP gas or biogas.”

Caution

FOR YOUR SAFETY - Do not install or operate your Pacific Energy gas stove without first reading and understanding this manual. Any installation or operational deviation from the following instructions voids the Pacific Energy™ Warranty and may prove hazardous.

This appliance and its individual shut off valve must be disconnected from gas supply piping system during any pressure testing of that system at test pressures in excess of 1/2 psig (3.5 kPa).

This appliance must be isolated from the gas supply piping system by closing its individual manual shut off valve during any pressure testing of the gas supply piping system at test pressures equal to or less than 1/2 psig (3.5 kPa).

Note: When lit for the first time, the appliance will emit a slight odour for a couple of hours. This is due to the curing of paints, sealants and lubricants used in the manufacturing process. This condition is temporary. Open doors and windows to ventilate area. Smoke and fumes caused by the curing process may cause discomfort to some individuals.

Do not use the gas stove if any part has been under water. Immediately call a qualified service technician to inspect the gas stove and to replace any part of the control system and any gas control which has been under water.

This stove is equipped with a micro mesh safety screen for your protection and must be installed with the unit. Removal of the safety screen will cause the stove to become a burn hazard.



DANGER



HOT GLASS WILL CAUSE BURNS.

DO NOT TOUCH GLASS UNTIL COOLED.

NEVER ALLOW CHILDREN TO TOUCH GLASS.

A barrier designed to reduce the risk of burns from the hot viewing glass is provided with the appliance and shall be installed for the protection of children and other at-risk individuals.

Safety

Due to high temperatures, this gas appliance should be located out of traffic and away from furniture and draperies.

Children and adults should be alerted to the hazards of high surface temperatures and should stay away to avoid burns or clothing ignition.

Young children should be carefully supervised when they are in the same room as the appliance. Toddlers, young children, and others may be susceptible to accidental contact burns. A physical barrier is recommended if there are at-risk individuals in the house. To restrict access to a fireplace or stove, install an adjustable safety gate to keep toddlers, young children, and other at-risk individuals out of the room and away from hot surfaces. Clothing or other flammable material should not be placed on or near the appliance.

Any grill, panel or door removed for servicing the unit must be replaced prior to operating. Failure to do so may create a hazardous condition.

Installation and repair should be done by a qualified service person. The appliance should be inspected before use and at least annually by a professional service person. More frequent cleaning may be required due to excessive lint from carpeting, bedding material, etc. It is imperative that control compartments, burners and circulating air passageways of the appliance be kept clean.

It is our policy that no responsibility is assumed by the Company or by any of its employees or representatives for any damages caused by an inoperable, inadequate, or unsafe condition which is the result, either directly or indirectly, of any improper operation or installation procedures.

This appliance must not be connected to a chimney flue serving a separate solid fuel burning appliance.

Warnings and Cautions

- DO NOT SPRAY AEROSOLS IN THE VICINITY OF THIS APPLIANCE WHILE IT'S IN OPERATION.
- DO NOT USE OR STORE FLAMMABLE MATERIALS IN OR NEAR THIS APPLIANCE.
- DO NOT PLACE ARTICLES ON OR AGAINST THIS APPLIANCE.
- DO NOT MODIFY THIS APPLIANCE.

WARNING

SHOCK HAZARD. CAN CAUSE SEVERE INJURY OR DEATH. THIS DEVICE IS POWERED BY LINE VOLTAGE. DO NOT TRY TO REPAIR THIS DEVICE. IN NO WAY IS THE ENCLOSURE TO BE TAMPERED WITH OR OPENED. DISCONNECT FROM LINE VOLTAGE BEFORE PERFORMING ANY MAINTENANCE.

DUE TO HIGH TEMPERATURES, THIS GAS APPLIANCE SHOULD BE LOCATED OUT OF TRAFFIC AND AWAY FROM FURNITURE AND DRAPERIES.

CHILDREN AND ADULTS SHOULD BE ALERTED TO THE HAZARDS OF HIGH SURFACE TEMPERATURES AND SHOULD STAY AWAY TO AVOID BURNS OR CLOTHING IGNITION.

YOUNG CHILDREN SHOULD BE CAREFULLY SUPERVISED WHEN THEY ARE IN THE SAME ROOM AS THE APPLIANCE. TODDLERS, YOUNG CHILDREN AND OTHERS MAY BE SUSCEPTIBLE TO ACCIDENTAL CONTACT BURNS. A PHYSICAL BARRIER IS RECOMMENDED IF THERE ARE AT RISK INDIVIDUALS IN THE HOUSE. TO RESTRICT ACCESS TO A FIREPLACE OR STOVE, INSTALL AN ADJUSTABLE SAFETY GATE TO KEEP TODDLERS, YOUNG CHILDREN AND OTHER AT RISK INDIVIDUALS OUT OF THE ROOM AND AWAY FROM HOT SURFACES.

CLOTHING OR OTHER FLAMMABLE MATERIAL SHOULD NOT BE PLACED ON OR NEAR THE APPLIANCE.

THE GUARD IS FITTED TO THIS APPLIANCE TO REDUCE THE RISK OF FIRE OR INJURY FROM BURNS AND NO PART OF IT SHOULD BE PERMANENTLY REMOVED. FOR PROTECTION OF YOUNG CHILDREN OR THE INFIRM, A SECONDARY GUARD IS REQUIRED.

DO NOT INSTALL IN A FIREPLACE.

WARNING

FIRE HAZARD. CAN CAUSE SEVERE INJURY OR DEATH. THE RECEIVER CAUSES IGNITION OF THE APPLIANCE. THE APPLIANCE CAN TURN ON SUDDENLY. KEEP AWAY FROM THE APPLIANCE BURNER WHEN OPERATING THE REMOTE SYSTEM OR ACTIVATING MANUAL BYPASS OF THE REMOTE SYSTEM.

INSTALLATION AND REPAIR SHOULD BE DONE BY A QUALIFIED SERVICE PERSON. THE APPLIANCE SHOULD BE INSPECTED BEFORE USE AND AT LEAST ANNUALLY BY A PROFESSIONAL SERVICE PERSON. MORE FREQUENT CLEANING MAY BE REQUIRED DUE TO EXCESSIVE LINT FROM CARPETING, BEDDING MATERIAL, ETC. IT IS IMPERATIVE THAT CONTROL COMPARTMENTS, BURNERS AND CIRCULATING AIR PASSAGEWAYS OF THE APPLIANCE BE KEPT CLEAN.

THIS APPLIANCE MUST NOT BE CONNECTED TO A CHIMNEY FLUE SERVING A SEPARATE SOLID FUEL BURNING APPLIANCE.

WARNING: FAILURE TO INSTALL THIS APPLIANCE CORRECTLY WILL VOID YOUR WARRANTY AND MAY CAUSE A SERIOUS HOUSE FIRE.

Congratulations on your purchase of a Pacific Energy Gas Appliance.

Your appliance has been professionally installed by:

Dealer name: _____

Phone Number: _____

If you discover any problems with your gas appliance contact your dealer immediately to have the unit repaired.

Caution: Do not attempt to repair the fireplace because you may cause injury to yourself or others, and risk causing damage to the unit.

Before operating your appliance carefully read this manual and pay close attention to all Safety Warnings.

The manual contains important information on the unit's safe operation and maintenance.



Operating Instructions

Warning: The home owner must not make any adjustments to the appliance other than what can be achieved by using the remote handset (Figure 1) and the settings control / battery holder located at the bottom of the surround backing plate (Figure 20). Any other adjustments must be performed by a qualified service technician.

Before operating this appliance, proceed through the following checklist.

1. Read and understand these instructions before operating this appliance.
2. Check to see that all wiring is correct and enclosed to prevent possible shock.
3. Check to ensure that there are no gas leaks.
4. Make sure that the glass door is in place. Never operate the appliance with the glass door removed.
5. Verify that all flueing and the termination cap is unobstructed.
6. Verify log placement.
7. When lighting the appliance, the inside of the glass may fog up. This will burn off after a few minutes of operation.

NOTE: After 3 failed attempts to ignite, the fireplace will enter a 1 minute hibernation period before attempting to ignite again.

NOTE: Fireplace may take up to 30 seconds to ignite each time the "ON" button has been selected.

First Fire

When lit for the first time, the gas stove will emit a slight odour for a couple of hours. This is due to the curing of paints, sealants and lubricants used in the manufacturing process. This condition is temporary. Open doors and windows to ventilate area. Odors caused by the curing process may cause discomfort to some individuals.

It is normal for stoves fabricated of steel to give off some expansion and/or contraction noises during the start up or cool down cycle. Similar noises are found with your furnace heat exchanger or cook stove oven.

Special Operator Note

NOTE: Pilot may take up to 30 seconds to ignite each time the "ON" button has been selected.

Remote Control Operation

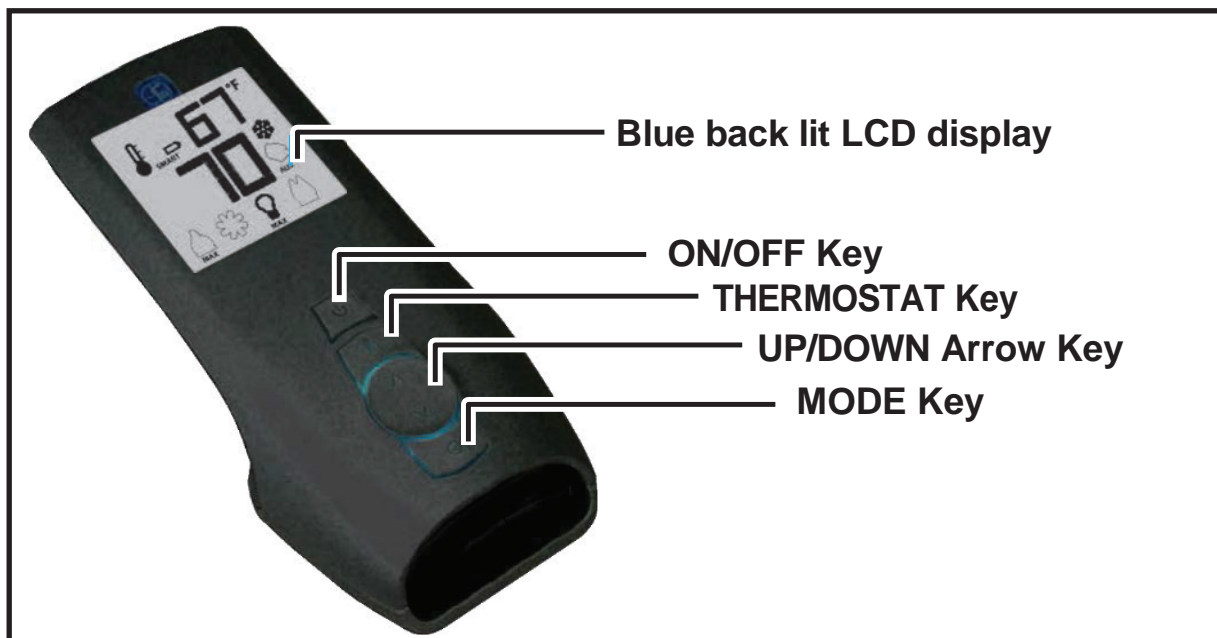

Figure 1: Proflame 2 handset.

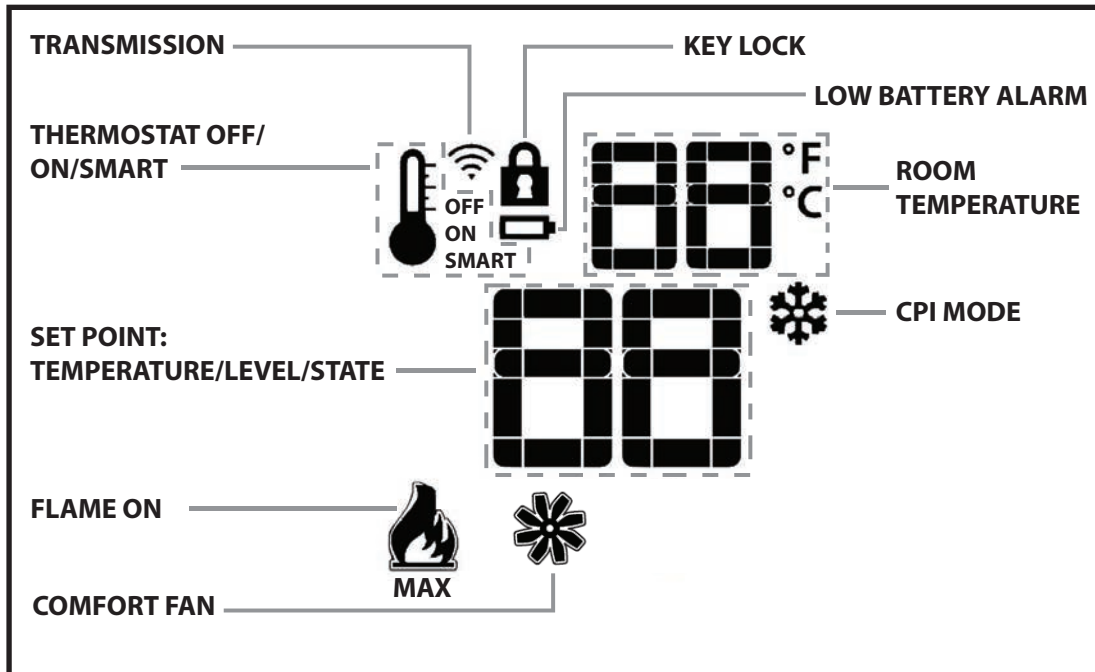

Figure 2: Proflame 2 LCD display.

Attention!

- Turn off the main gas supply for the appliance during installation or maintenance of the receiver/module device.
- Turn off main gas supply for the appliance prior to removing or reinserting the batteries.
- In case of remote control malfunction, turn off the fireplace using the “on/off” main switch located on back of stove.
- For installation/maintenance, turn off the fireplace at the on/off switch located on the back of the unit and at the fireplace power supply circuit breaker.

Remote Transmitter Description

The Proflame2 Remote Control consists of two elements:

1. Proflame2 Remote Control Transmitter.
2. Proflame Integrated Fireplace Control (IFC Module) board and a wiring harness to connect the IFC to the gas valve and stepper motor (Figure 43).

Transmitter (Remote Control with LCD Display)

The Proflame 2 Transmitter uses a streamline design with a simple key layout and an informative LCD display (Figure 2). The remote control transmitter is powered by 3 AAA batteries. A mode key is provided to index between the features and a thermostat key is used to turn on/off or index through thermostat functions (Figure 1).

IFC Module

The Proflame2 Integrated Fireplace Control (IFC) module is a device that allows automatic ignition and pilot flame supervision and commands the functions of the fireplace. It's configured to control the ON/OFF main burner operation, giving the choice of both IPI (intermittent pilot ignition), and CPI (continuous pilot ignition) modes. The Proflame 2 IFC module controls and connects directly to the pilot assembly and the automatic valve using low electric power.

The IFC module can be powered by both an AC power supply, and battery pack for back up. The Proflame 2 offers the added ability to control the comfort fan speed from OFF through six (6) speeds. The external batteries can provide DC power to the IFC allowing the batteries to be used only when line power is interrupted or lost.

Operating Procedure

Initializing the Fireplace for the first time

1. With the gas stove power plug unplugged and the main switch - located in the rear of the stove, turned to the OFF position, remove the switches' face plate and install 4 AA batteries into the battery holder (Figure 20). Once the batteries are installed and the switches' face plate reattached, turn the selection switch to "Remote" setting.
2. Install 3 AAA batteries into the Proflame 2 Remote Control Transmitter (Figure 3).
3. Plug the power plug in and turn on the gas supply.
4. Insert a straightened paper clip into the opening marked "PRG" of the switches' face plate Figure 20 and press the program key once (alternately, if the face plate is already off, simply press the "PRG" button on the battery holder). The IFC module, also located on the inside of the gas stove enclosure, will beep 3 times indicating that it is ready to synchronize with a remote control transmitter.
5. On the remote control transmitter, push the power on key once. The remote control transmitter will beep 4 times to indicate that the remote control transmitter and the IFC module are now synchronized. The remote control transmitter is now ready to use.

Using the Remote Control Transmitter

Temperature indication Display

With the remote control transmitter in the “OFF” position, press the thermostat and mode keys at the same time. Look at the LCD screen on the remote control transmitter to verify that a C or F is visible to the right of the room temperature display (Figure 4 and Figure 5).

Turn on the Stove

With the stove OFF, press the ON/OFF key on the remote control transmitter. The remote control transmitter display will show the active icons on the screen. At the same time the wall switch will activate the stove via the IFC module. A single “beep” from the IFC module will confirm reception of the command.

Turn off the Stove

With the stove ON, press the ON/OFF key on the remote control transmitter. The remote control transmitter LCD display will only show the room temperature (Figure 4 and Figure 5). At the same time the IFC module will turn off the stove. A single “beep” from the IFC module confirms reception of the command.

Manual Bypass of the Remote Control Transmitter

If the batteries of the remote control transmitter are low or depleted, the gas stove can be turned off manually using ON/OFF switch located on rear of the gas stove (Figure 20). This will bypass the remote control transmitter.

Remote Flame Control

The Proflame 2 has six (6) flame levels (Figure 6). With the gas stove turned on, and the flame level at maximum height, press the down arrow key once to reduce the flame height by one step until the flame is turned off.

The up arrow key will increase the flame height each time it is pressed. If the up arrow key is pressed while the gas stove is on but the flame is off, the flame will come on in the high position. A single “beep” will confirm reception of the command.



Figure 3: Proflame 2 remote control battery bay.

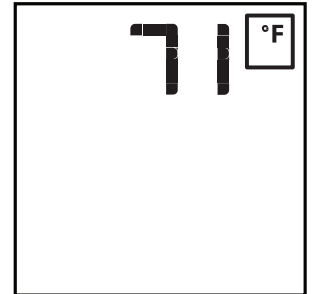

Figure 4: Display in Fahrenheit.

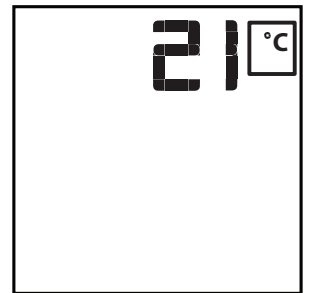
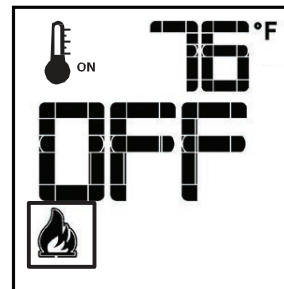
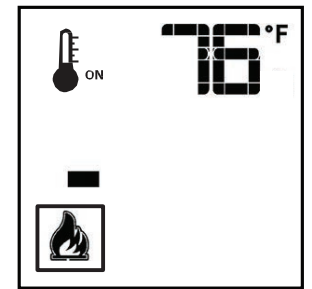

Figure 5: Display in Celsius.



Flame level OFF



Flame level 1

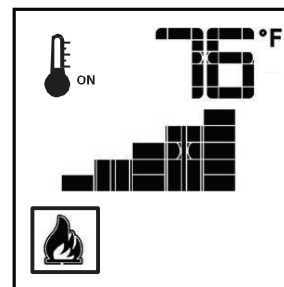

Flame level 5

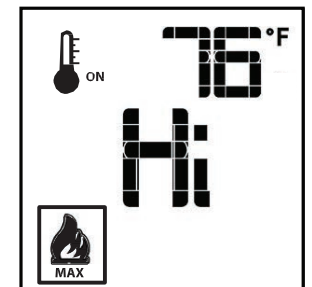

Flame level MAX

Figure 6: Flame level control.

Room Thermostat (Transmitter Operation)

The remote control transmitter can operate as a room thermostat. The thermostat can be set to a desired temperature to control the comfort level in a room. To activate this function, press the thermostat button (Figure 1), the LCD display on the remote control transmitter will change to show that the room thermostat is “ON” and the set temperature is now displayed (Figure 7). To adjust the set point, press the up or down arrow button until the desired set point temperature is displayed on the LCD screen of the remote control transmitter.

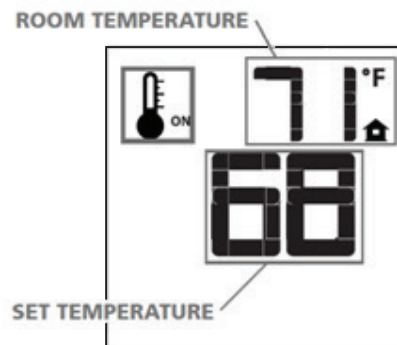

Figure 7: Room temperature.

Smart Thermostat (Transmitter Operation)

The Smart Thermostat function adjusts the flame height in accordance to the difference between the set point and the room temperatures. As the room temperature gets closer to the set point, the Smart Function will modulate the flame down. If the room temperature is cool, the Smart Function will modulate the flame up. To activate this function, press the THERMOSTAT button (Figure 1) until the word “SMART” appears to the right of the temperature icon Figure 8. To adjust the set point, press the up or down arrow buttons on the handset until the desired set point temperature is displayed on the LCD screen of the remote control transmitter (Figure 9).

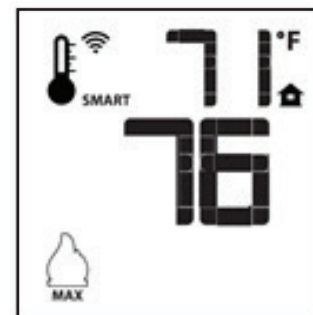

Figure 8: Smart flame function MAX temp.

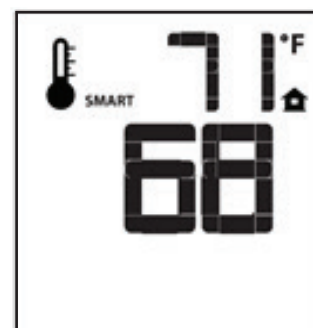

Figure 9: Smart flame adjusting temperature.

Comfort Fan Speed Control

If the Stove is equipped with a hot air circulating fan, the speed of the fan can be controlled by the Proflame 2 System. The fan speed can be adjusted through six (6) speeds (Figure 10). To activate this function use the Mode Key (Figure 1) to index to the fan control icon (Figure 11). Use the Up/Down Arrow Keys (Figure 1) to turn on, off or adjust the fan speed (Figure 23). A single “beep” will confirm reception of the command.

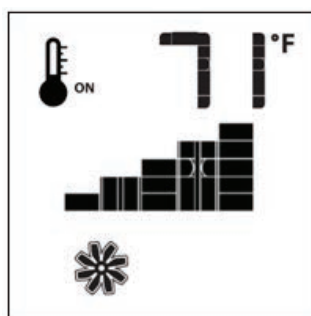

Figure 10: Comfort fan max.



Figure 11: Comfort fan off.

Continuous Pilot/Intermittent Pilot (CPI/IPI) selection

With the system in the “OFF” position, press the Mode Key (Figure 1) to index to the CPI mode icon (Figure 12). Pressing the Up Arrow Key will activate the Continuous Pilot Ignition mode (CPI). Pressing the Down Arrow Key will return to IPI. A single “beep” will confirm the reception of the command.

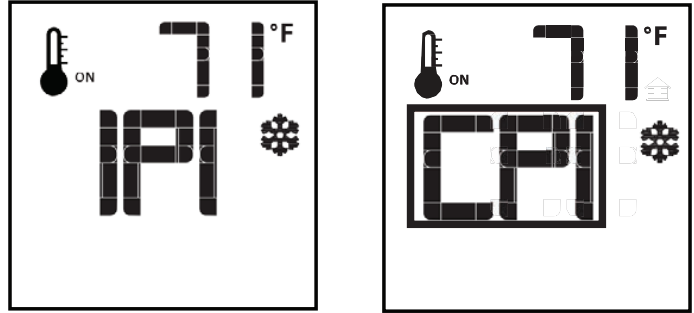

Figure 12: IPI - CPI control.

Key Lock

This function will lock the keys to avoid unsupervised operation. To activate this function, press the MODE and UP keys at the same time (Figure 1). The lock icon will appear (Figure 13). To deactivate this function, press the MODE and UP key at the same time.

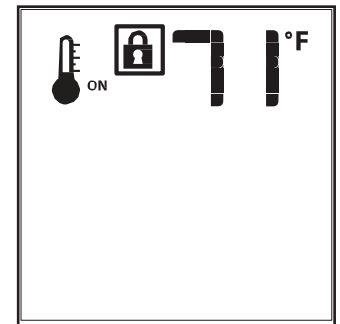

Figure 13: Key lock.

Low Battery Power Detection Transmitter

The life span of the remote control batteries depends on various factors: quality of the batteries used, the number of ignitions of the Stove, the number of changes to the room thermostat set point, etc.

When the remote control transmitters' batteries are low, an icon will appear on the LCD display (Figure 14) of the remote before all battery power is lost. When the batteries are replaced this icon will disappear.

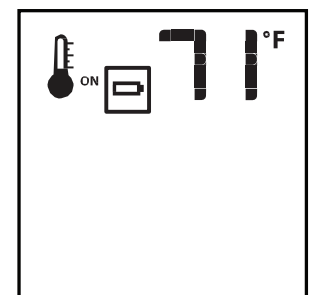

Figure 14: Low battery.

Receiver

The life span of the IFC module batteries depend on various factors: quality of the batteries used, the number of ignitions of the Stove, the number of changes to the room thermostat set point, etc.

When the IFC batteries are low, a “double-beep” will be emitted from the IFC module when it receives a command from the remote. This is an alert for a low battery condition for the IFC module. When the batteries are replaced, a single “beep” will be emitted from the IFC module when a key is pressed - “Initializing the Fireplace for the first time” on page 10.

Lighting Instructions

FOR YOUR SAFETY READ BEFORE LIGHTING

WARNING: If you do not follow these instructions exactly, a fire or explosion may result causing property damage, personal injury or loss of life.

- A. This appliance is equipped with an ignition device which automatically lights the pilot. Do not try to light the pilot by hand.
- B. **BEFORE LIGHTING** smell all around the appliance area for gas. Be sure to smell next to the floor because some gas is heavier than air and will settle on the floor.
- WHAT TO DO IF YOU SMELL GAS:**
- Do not try to light any appliance.
 - Do not touch any electric switch; do not use any phone in your building.

- Immediately call your gas supplier from a neighbour's phone. Follow the gas supplier's instructions.
 - If you cannot reach your gas supplier, call the fire department.
- C. Use only your hand to push in or turn the gas control knob. Never use tools. If the knob will not push in or turn by hand, don't try to repair it, call a qualified service technician. Force or attempted repair may result in a fire or explosion.
- D. Do not use this appliance if any part has been under water. Immediately call a qualified service technician to inspect the appliance & to replace any part of the control system & any gas control which has been under water.

LIGHTING INSTRUCTIONS

1. **STOP!** Read the safety information above on this label.
2. This appliance is equipped with an ignition device which automatically lights the pilot. Do not try to light the pilot by hand.
3. Push the "On/ Off" switch to turn the fireplace ON.
 - If the burner does light go to step 6.
 - If the burner does not light, complete steps 4 through 5.
 - If the burner will not light or stay lit after several tries, push the "On/ Off" switch for the fireplace to OFF, turn off all electric power

to the fireplace and call your service technician or gas supplier.
Note: Sufficient time must be allowed for air to escape from lines if the unit is being lit for the first time.

4. Push the "On/ Off" switch to the fireplace Off.
5. Allow sufficient length of time (minimum 5 minutes) for any gas in the combustion chamber to escape. If you still smell gas, **STOP!** Follow "B" in the safety information above on this label. If you don't smell gas, go to step 3.
6. Set fireplace to desired setting by using hand held remote.

TO TURN OFF GAS APPLIANCE

1. Push the "on/ off" switch to the "Off" position.

2. Turn off all electric power to the appliance and remove backup batteries if service is to be performed or for extended shutdown.

Due to high surface temperatures, keep children, clothing and furniture away. Keep burner and control compartment clean. See installation and operating instructions accompanying the appliance.

A cause de la température élevée des parois, tenir éloignés les enfants, les vêtements et les meubles. Maintenir propres le brûleur et le compartiment de commande. Voir les instructions relatives à l'installation et au fonctionnement qui accompagnent l'appareil.

CAUTION: Hot while in operation. Do not touch. Severe burns may result. Keep children, clothing, furniture, gasoline and other liquids having flammable vapours away. Keep burner and control compartment clean. See installation and operating instructions accompanying the appliance.

ATTENTION: L'appareil est chaud lorsqu'il fonctionne. Ne pas toucher l'appareil. Risque de brûlures graves. Surveiller les enfants. Garder les vêtements, le meubles, l'essence ou autres liquides produisant des vapeurs inflammables loin de l'appareil. S'assurer que le brûleur et le compartiment des commandes sont propres. Voir les instructions d'installation et d'utilisation qui accompagnent l'appareil.

050615

5051.185

MR18/G958

Figure 15: Mirage 18 Lighting Instructions.

Installation Checklist

1. Uncrate the Mirage 18. Examine for shipping damage and that the shipping list is complete.
2. Review the following:
 - Mirage 18 dimensions (page 16).
 - Locating the Stove (page 17).
 - Clearances to combustibles (page 18).
 - FlueTerminal Minimum Clearances (page 19).
 - Co-axial flueing chart (page 20).
3. Install flueing.
4. Make gas and electrical connections (page 21).
5. Gas pressure check.
6. Gas pressure testing procedure (page 23).
7. Firebox panel set installation .
8. Glass or log set installation (page 26).
9. Door installation (page 28).
10. Install backup batteries and link the hand transmitter to the Mirage 18 (page 29).
11. Adjustments (page 30)
12. Final check.

Before leaving this unit with the customer, the installer must ensure that the appliance is firing correctly and operation fully explained to the customer.

This includes:

- Adjusting flue damper if flame is too hectic.
- If required, adjusting the primary air to ensure that the flame does not carbon. First allow the unit to burn for 15 - 20 minutes to stabilize.

Caution: Any alteration to the product that causes sooting or carboning that results in damage is not the responsibility of the manufacturer.

Mirage 18 Dimensions

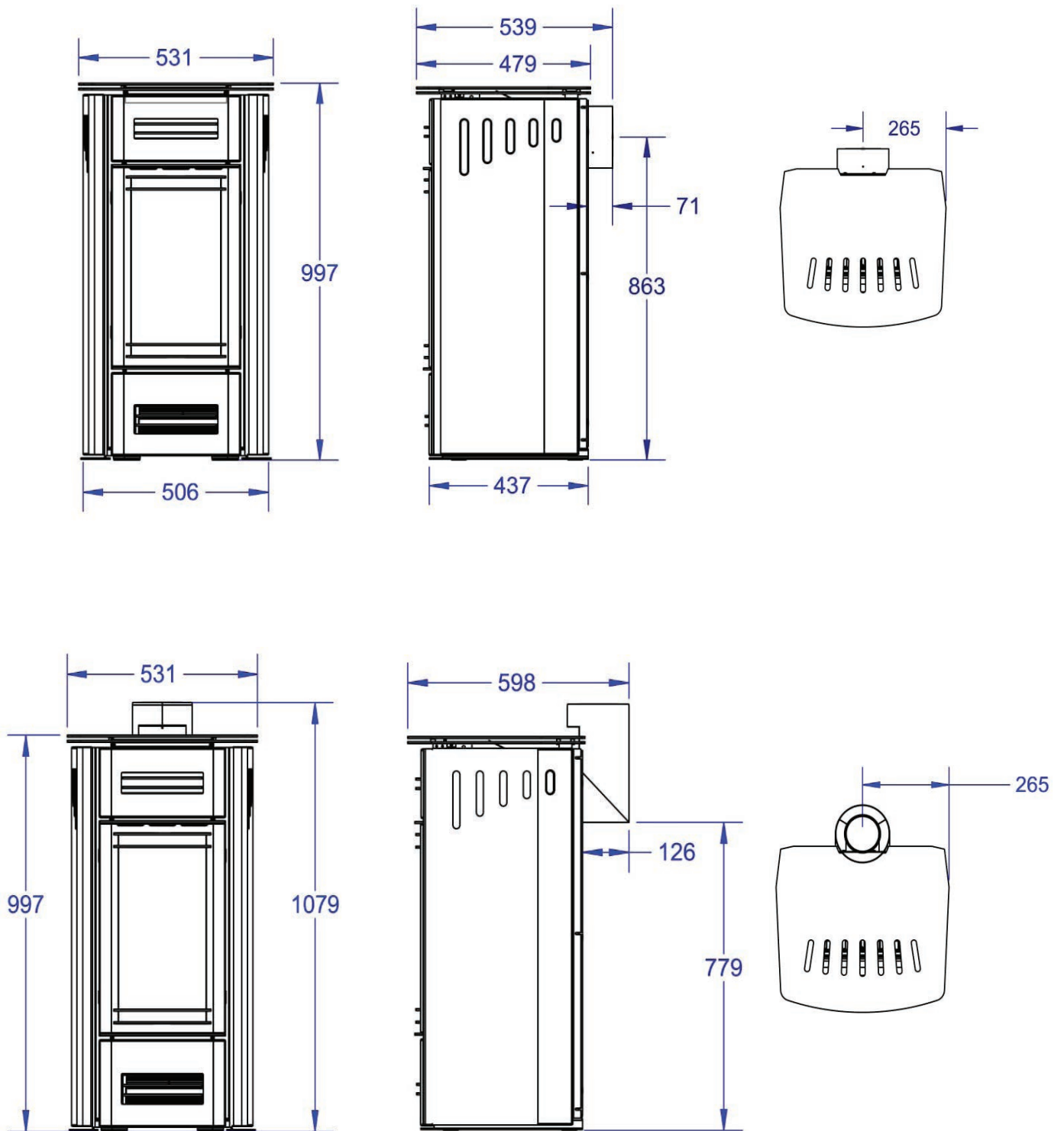

Figure 16: Mirage 18 Dimensions.

Locating the Stove

In planning the installation for the stove, it is necessary to determine where the unit is to be installed, location of flue system or a wall projection (Figure 17). Due to high temperatures, do not locate this stove in areas of high traffic, near furniture or draperies. Also keep in mind that if the unit is positioned to its' minimum clearances as shown in Figure 18, the unit may need to be moved in order to perform service at a later date, depending on the nature of service to be performed.

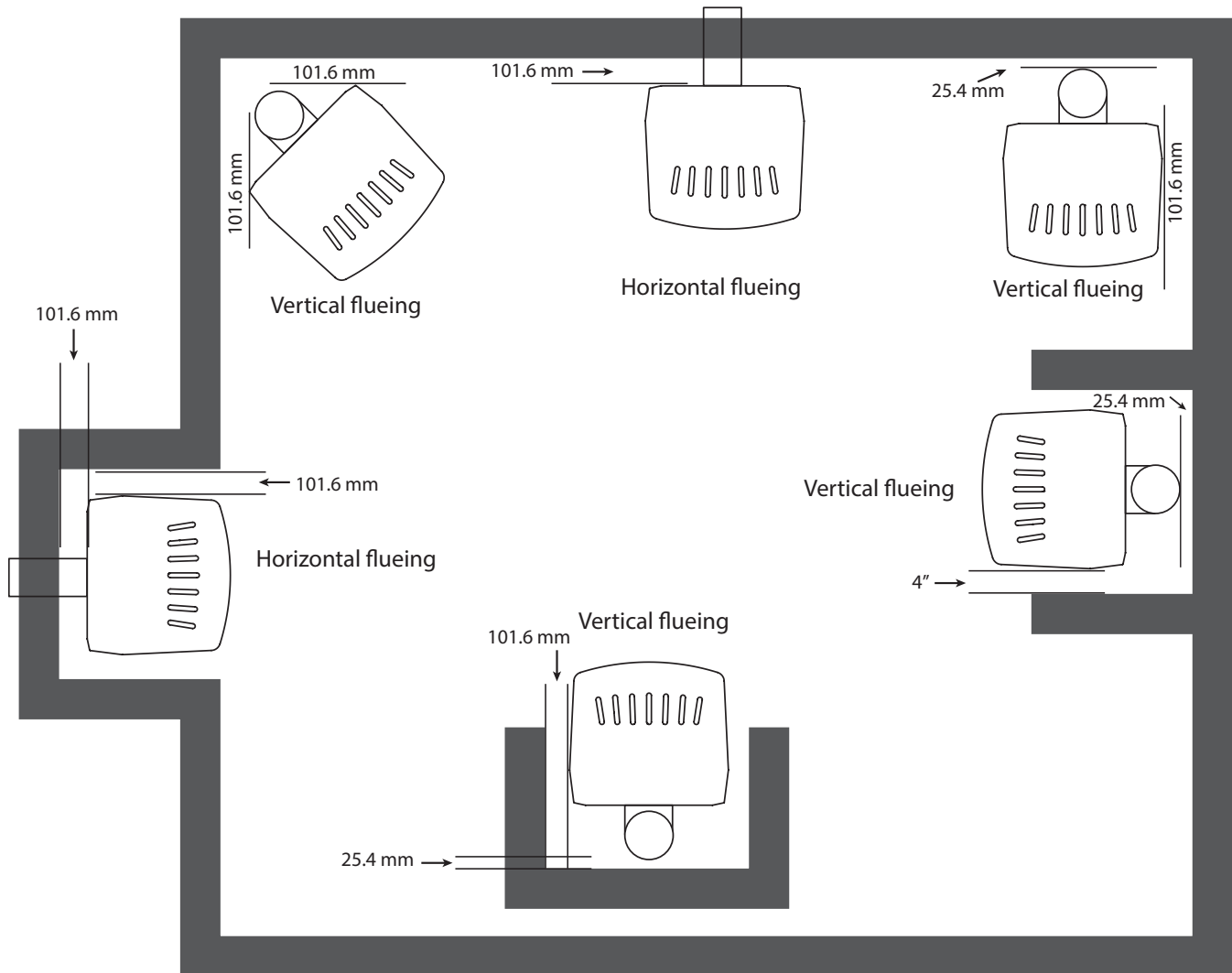

Figure 17: Mirage 18 Common locations & minimum clearances.

Clearances to Combustibles

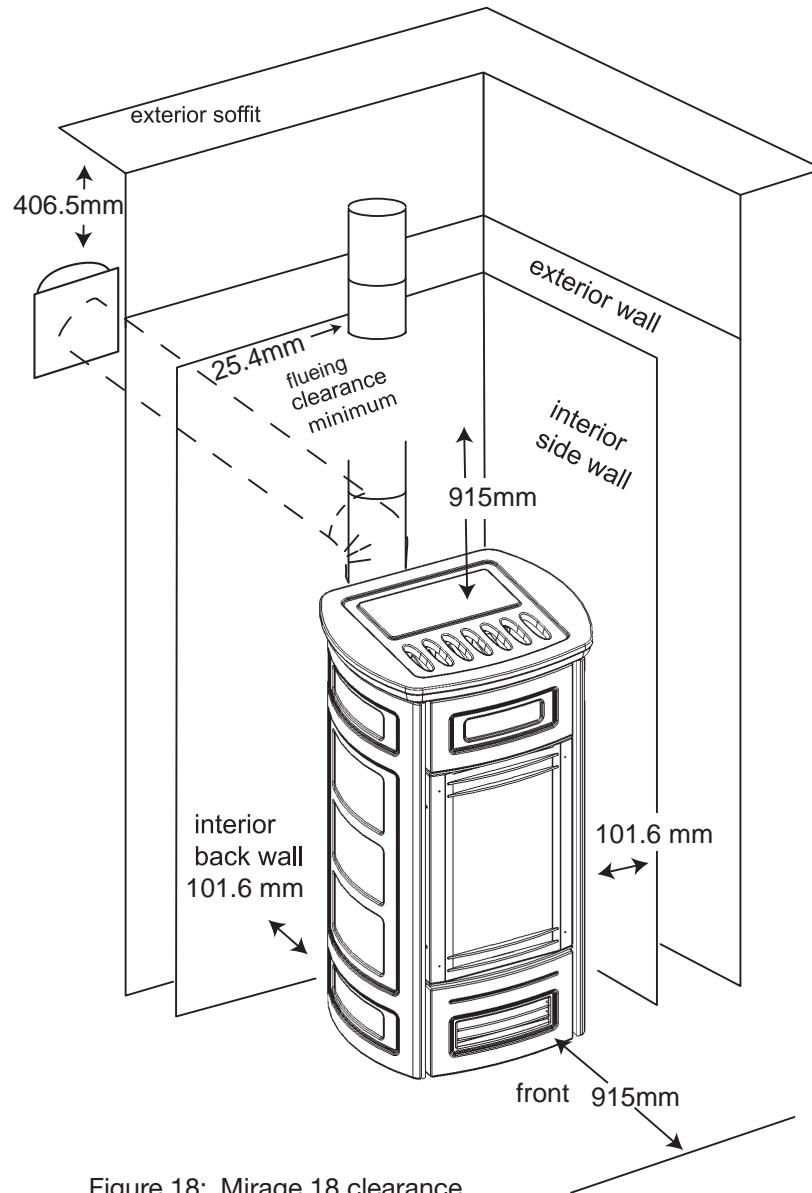

Figure 18: Mirage 18 clearance to combustibles.

Minimum Clearance to Combustible Materials

INTERIOR SIDE WALL	101.6 mm
INTERIOR BACK WALL	101.6 mm
INTERIOR CEILING	915 mm
IN FRONT OF HEATER	915 mm
FLUEING CLEARANCE	25.4 mm
EXTERIOR SOFFIT	406.5 mm

Note on corner placement

Refer to minimum clearances as shown in Figure 17.

Refer to Figure 19 for flueing allowances.

Flue Terminal Minimum Clearances

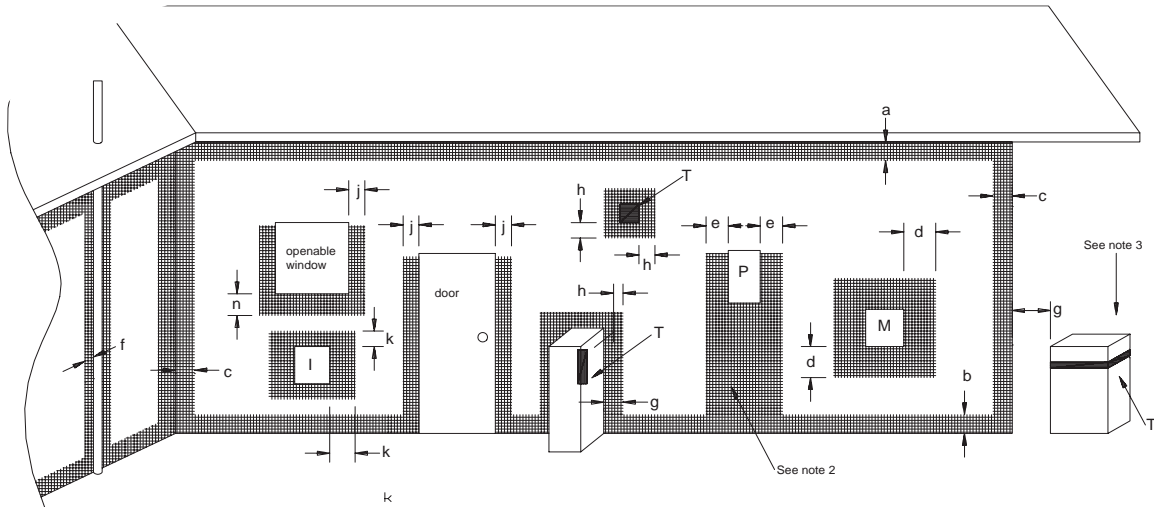

T = Flue terminal M = Gas meter
 I = Mechanical air inlet P = Electricity meter or fuse box

Shading indicates prohibited areas for flue terminals

- MIN. CLEARANCE (mm)**
- a - Below eaves, balconies or other projections:
 - Appliances up to 50 MJ/h input 300
 - Appliances over 50 MJ/h input 500
 - b - From the ground or above a balcony 300
 - c - From a return wall or external corner 500
 - d - From a gas meter (M) 1000
 - e - From an electricity meter or fuse box (P) 500
 - f - From a drain or soil pipe 150
 - g - Horizontally from any building structure (unless appliance approved for closer installation) or obstruction facing a terminal 500
 - h - From any other flue terminal, cowl, or combustion air intake 500
 - j - Horizontally from an openable window, door, non-mechanical air inlet, or any other opening into a building, with the exception of sub-floor ventilation:
 - Appliances up to 150 MJ/h input 500
 - Appliances over 150 MJ/h input 1500
 - k - From a mechanical air inlet, including a spa blower 1500
 - n - Vertically below an openable window, non-mechanical air inlet or any other opening into a building, with the exception of See table sub-floor ventilation below

CLEARANCE 'n' (mm)			
Space Heaters	All other appliances		
Up to 50 MJ/h input	Up to 50 MJ/h input	Over 50 MJ/h & up to 150 MJ/h	Over 150 MJ/h input
150	500	1000	1500

- NOTES:**
- All distances are measured vertically or horizontally along the wall to a point in line with the nearest part of the terminal.
 - Prohibited area below electricity meter or fuse box extends to ground level.
 - See clause 5.13.6.6 for restrictions on a flue terminal under a roofed area.
 - See Appendix J, Figure J1(a) and J2(a) for clearances required from a flue terminal to a LP Gas cylinder. A flue terminal is considered to be a source of ignition.

MINIMUM CLEARANCES REQUIRED FOR BALANCED FLUE TERMINALS OR THE FLUE TERMINALS OF OUTDOOR APPLIANCES

Co-axial Flueing

The Mirage 18 can be flued using co-axial components, and co-linear components for flueing through an existing fireplace and chimney. Maximum and minimum flueing lengths can be found on the flueing chart Figure 19.

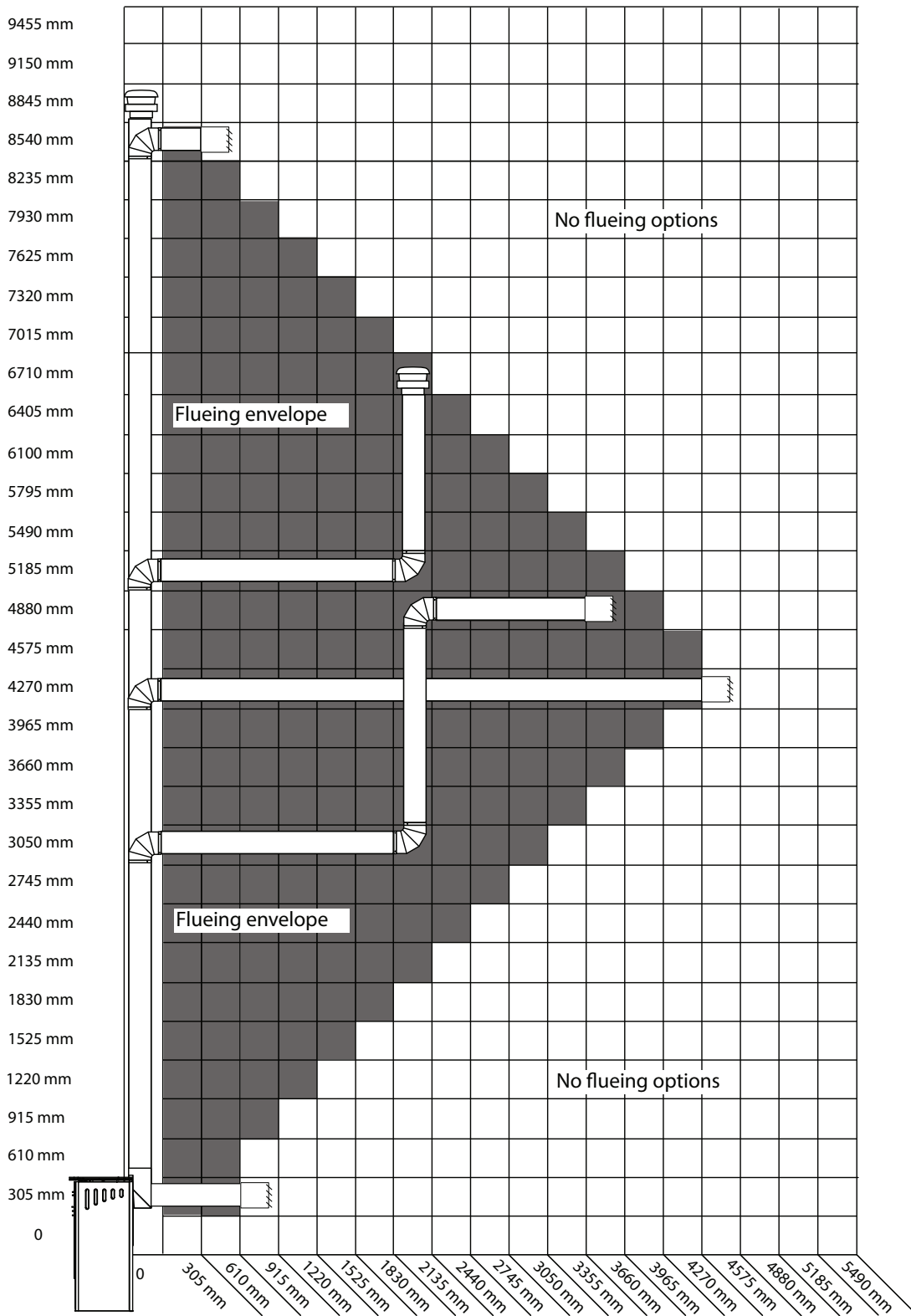

Note: The flue must not exceed a total length of 8534.4 mm. Any combination of rise and run may be used but must be constrained to the boundaries of this chart. A Maximum of three (3) 90° elbows may be used. Only one (1) 90° elbow or combination of other elbows equaling 90° can be used without reducing horizontal run. For each additional 90° elbow, or an equal combination of elbows, reduce horizontal flue run by 609.6 mm. Ensure flue pipe is properly supported.

Figure 19: Mirage venting chart 2.

Flue Components



46DVA-HSC
Horizontal
Terminal



46DVA-VCH
Vertical
Terminal

This fireplace is certified for use with 101.6mm x 168.275mm coaxial flue components only. It is permitted to only use Duravent certified flueing for this appliance.

Gas and Electrical Connections

Mirage 18 Electrical Rating: 240 Vac, 0.47 amp, 0.0373 kW

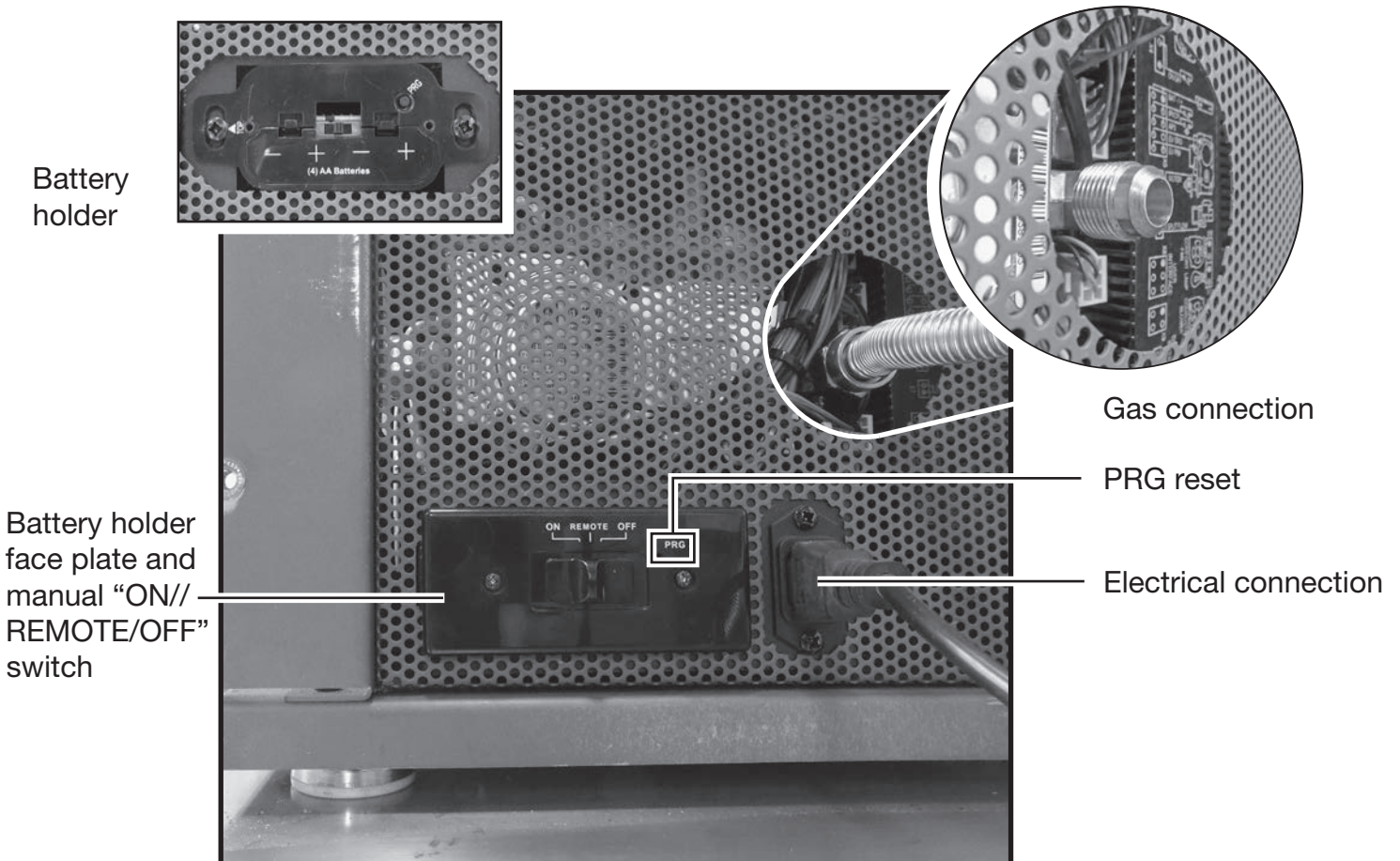

Figure 20: Gas and Electrical connection.

Gas connection

Connect the gas supply line to the 3/8" BSPT fitting at the rear of the unit as seen in Figure 20. Please see the gas supply section of this manual for requirements of the gas supply.

Electrical connection

Plug the provided IEC power cord into the receptacle at the rear of the unit as shown in Figure 20. The battery holder and manual “ON/REMOTE/OFF” switch are also located here. See details of operation on page 10.

Gas Supply

Servicing of the stove can be performed from the rear of the unit by removing the access panel from the unit.

Caution: The gas line should be installed by a qualified service person in accordance with all building codes. This section is intended as a guide for qualified technicians installing this stove. Consult local and/or national building codes before proceeding.

- Gas supply line connection is located on the rear of the stove. Gas connection accepts a ½” 45° flare fitting. Correct gas line diameter must be used to assure proper operation and pressure.
- The stove input rating is shown in the chart below.
- A drip leg must be installed in the gas supply line going to the gas control valve to minimize the possibility of any loose scale or dirt within the gas supply line from entering the control valve.
- It is essential that a union or flanged connection be installed just upstream of the valve to allow for repair or replacement of the gas valve.

Check local codes for additional requirements.

Turn on the gas supply and check that all connections are tight and leak free.

WARNING: The gas tray including gasket must be reinstalled after conversion/ installation or servicing has been completed.

Gas Pressure Check

Gas Type	Injector (mm)	MIN / MAX (MJ/hr)	Manifold Pressure (kPa)	Inlet Pressure (kPa)
Natural Gas	1.98	13.19 / 18.99	0,87	1.13
Propane	1.25	14.77 / 18.99	2.48	2.75

Gas Pressure Testing Procedure

Note: To test the gas pressure, turn off the gas supply to the stove before loosening test point screws. Verify gas pressures with the stove lit and at the highest setting.

1. Remove switch cover and back panel and locate the valve as seen in Figure 43.
2. Locate the inlet and outlet test points on the valve which can be seen in Figure 44. After locating test ports loosen the screws within the ports using a flat-tipped screwdriver.
3. Attach pressure gauge to the test ports.
4. Turn gas supply back on and test pressures.
5. After testing is finished turn off gas supply, remove the pressure gauges and re-tighten the screws in the test points.

Firebox Panel Removal / Installation

Note: The burner tray needs to be removed before installation or removal of panels - See "Burner Kit/Media Installation/Removal" on page 25.

Removal

1. After removing the burner tray, remove one of the side panel clips (Figure 22). Then allow the top portion of the side panel to move away from the firebox wall (Figure 22). When you have enough room, remove the panel from the stove.

2. Repeat step 1 to remove second side panel.

Note: With both side panels removed, there is nothing holding the upper back panel in place and so you must be ready to support and remove it at the same time as the side panel.

3. Remove the upper back panel by allowing it to tilt forward. Remove (Figure 24).

4. Remove the lower back panel by lifting it off of the pilot ledge and pull it out of stove (Figure 25).

Installation

1. Insert lower back panel so that it is sitting on the ledge at the back of the firebox (Figure 25).

2. Insert upper back panel so that it is sitting on top of the lower back panel as shown in (Figure 24). The panel must be supported until one of the side panels is mounted in place.

Note: There are two tabs in the bottom of the upper back

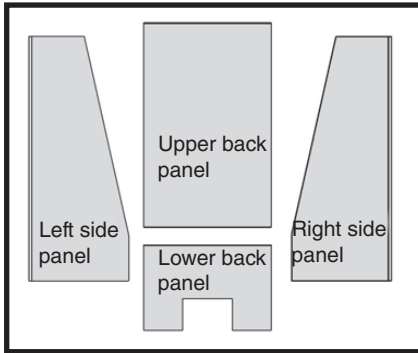

Figure 21: Interior panel set.

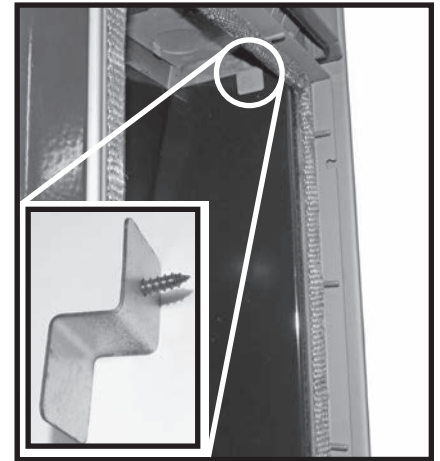

Figure 22: Side panel clip in place.



Figure 23: Right side panel.

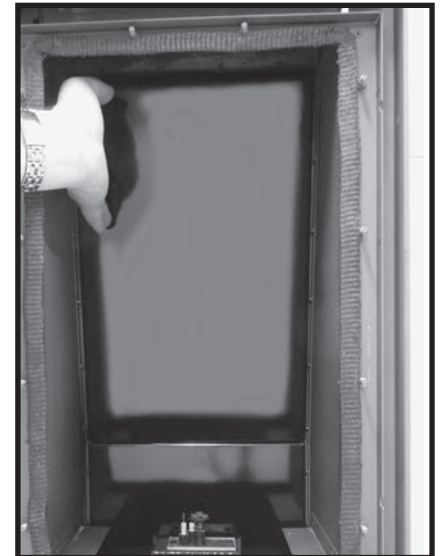

Figure 24: Upper back panel.

panel that fit into two slots on the top of the lower back panel.

3. Insert first side panel by tilting the panel into the firebox chamber. Then slide the panel until it reaches the firebox side wall. Secure panel by attaching the side panel clip.

4. Repeat step 3 for the second side panel.

5. Reinstall burner kit.

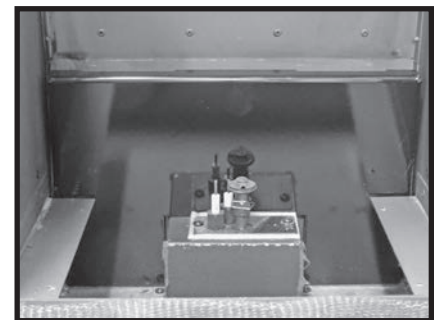

Figure 25: Lower back panel.

Burner Kit/Media Installation/Removal

Burner Tray Installation / Removal

Installation

Interior panels must be installed before burner tray can be installed. The injector must be removed prior to burner tray insertion (Figure 28). Remove 2 - 3/8" (9.525 mm) nuts and extract the injector from the firebox.

Insert the burner tray (Figure 26) and insert 4 Robertson screws to fix it in place. Reinstall the injector and two 3/8" (9.525 mm) nuts. Evenly spread a thin layer of crushed glass across the entire burner pan (Figure 30).

Note: It is not necessary to use the entire bag of crushed glass. Use enough to cover the burner tray with a single layer. Any more can interfere with proper flame distribution.

Removal

Begin by removing the exterior side panel on your right hand side as you face the Mirage 18 (Figure 47 on page 33).

Remove the injector from the side wall of the Mirage 18 (Figure 28).

Remove the glass media then remove the 4 screws (Figure 27) with a screwdriver, and remove the burner tray (Figure 27).

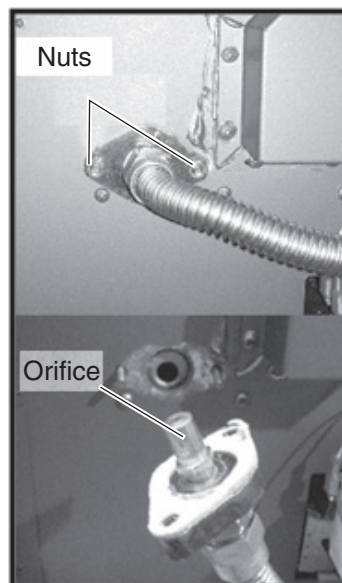

Figure 28: Orifice extraction.



Figure 26: Burner tray insertion and removal.

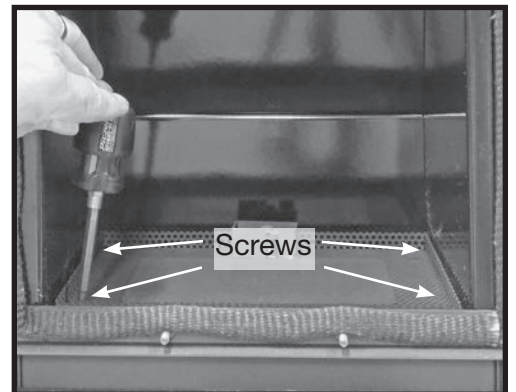

Figure 27: Unfastening the burner tray.

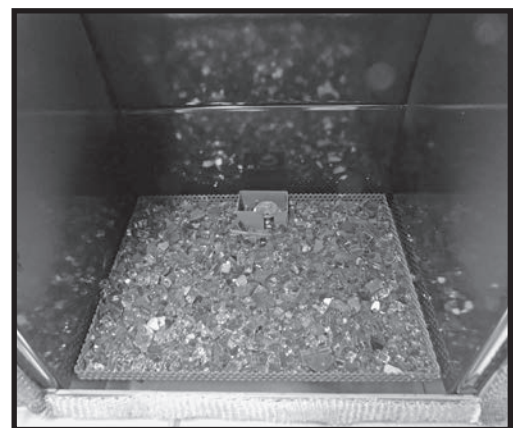

Figure 29: Glass media in burner tray.jpg

Optional Glass Media Installation

Evenly spread a thin layer of crushed glass across the entire burner pan (Figure 30).

Note: It is not necessary to use the entire bag of crushed glass. Use enough to cover the burner tray with a single layer. Any more can interfere with proper flame distribution.

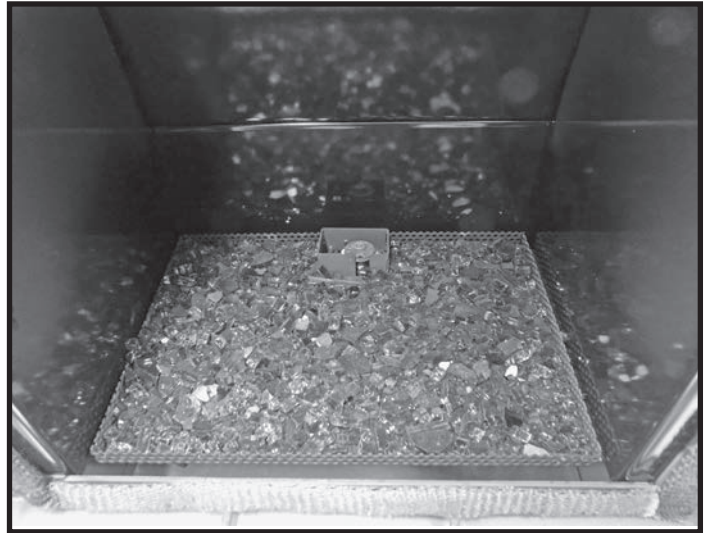

Figure 30: Glass media in burner tray.

Optional Log Media Installation

The Driftwood log-set with pebbles requires that any crushed glass media be removed if it is present. The pebbles are spread out around the perimeter of the burner basket after which the glowing embers are evenly spread out inside of the burner basket - (Figure 33). The stove is delivered with two media dividers - a large one for the Mirage 30 model (Figure 31), and a smaller one for the Mirage 18 model. The divider will be placed into the center of the burner basket (Figure 32) and is used to separate the pebbles and glowing embers.

Log Placement

1. Position rear log #1 at the back of the firebox on top of the pilot shield. (Figure 33)
2. Interlock right log #2 with rear log use the pin in the burner tray to position the log (Figure 34) .
3. Lean left log 3 against log set engage the pins in log #1 and the burner tray (Figure 35).
4. Interlock front log #4 with left log and use the pin in the burner tray to position the log (Figure 36) .

Note: Do Not Block Pilot With Logs



Figure 31: Media divider.

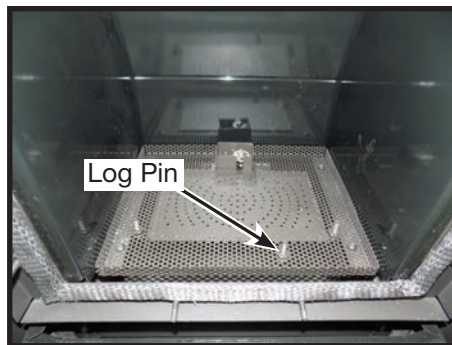

Figure 32: Media divider in place.

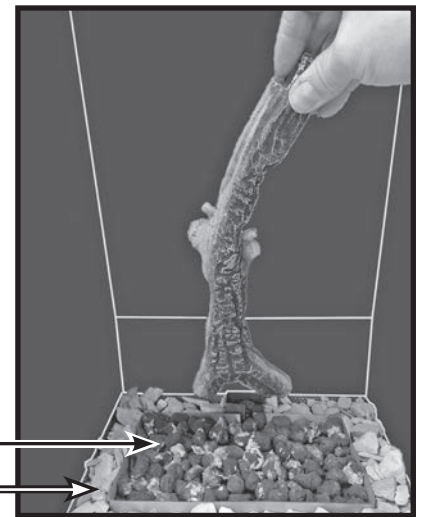

Figure 33: Log 1.

Note: Keep gap in media divider (Figure 31) faced to the rear of the burner basket, next to the pilot assembly.

Note: It is not necessary to use the entire contents of the Embers bag and the Rocks bag. Use enough to cover the burner tray with a single layer. Any more can interfere with proper flame distribution.

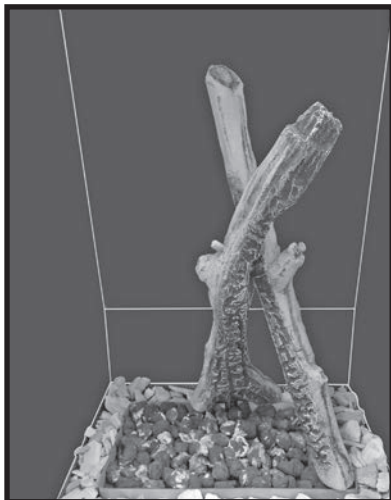

Figure 34: Log 2.

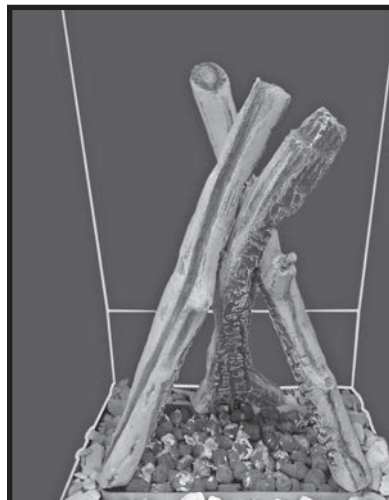

Figure 35: Log 3.



Figure 36: Log 4.

Door Removal / Installation



Figure 37: Securing the glass door.

Removal

1. Lift the mesh screen cover up and pull away from unit (Figure 38).
2. Remove the 12 3/8" (9.525 mm) nuts (Figure 37) Carefully remove the glass retainer with the glass by tilting the top towards you.

Installation

1. Position the glass retainer's frame so that the studs on unit align with holes in frame. Secure using 12 3/8" (9.525 mm) nuts.

CAUTION: Over tightening of nuts could result in glass fracturing.

2. Insert and lower the screen mesh cover by positioning the door's pins into the slots in the firebox frame.



Figure 38: Screen panel installation.

Battery Installation

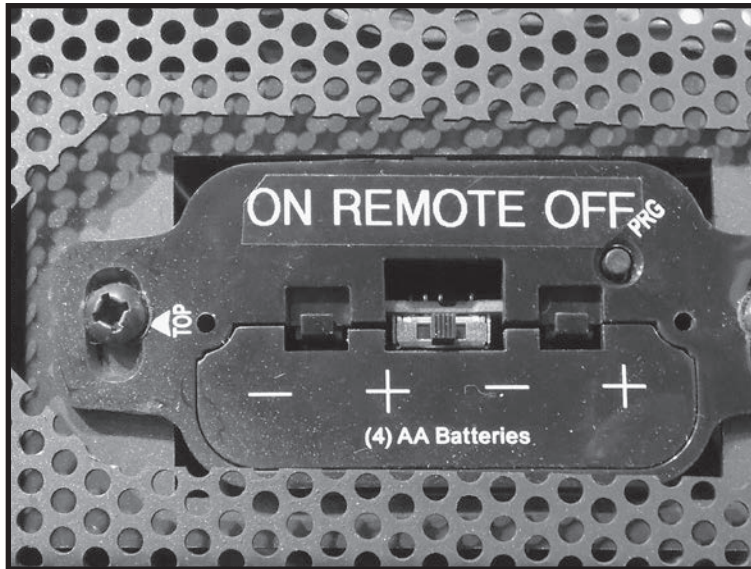

Figure 39: Receiver with battery holder and settings controls.

Batteries are used for remote operation and as a backup in case of a power outage.

For the Receiver: Install four double A batteries by removing the outer cover plate (if present), and the inner cover as shown in Figure 39. Install batteries. For normal operation using the remote transmitter, place the selection switch in the center "REMOTE" position. In case of a power outage, the heater can be turned off and on manually using the same selection switch. The program button (PRG) is found here as well.

The remote transmitter requires three triple A batteries inserted under the cover located on the bottom of the unit (Figure 40).



Figure 40: SIT remote.

Air Adjustment



Figure 41: Venturi fully open.



Figure 42: Venturi fully closed.

The venturi comes from the factory set to the closed position for use with natural gas. It will need to be adjusted toward the open position for use with propane. To adjust the venturi, the right hand side panel must be removed; See “Exterior Panel Removal/Installation” on page 33. To the left of the gas supply hose is a wing nut which can be move to the left or right (Figure 41 or Figure 42). Loosening and moving the wing-nut to the left opens the venturi and loosening and moving the wing-nut to the right closes the venturi. The setting will depend on several variables such as which type of gas is being used, the volume of air being supplied, the length of flueing etc.

NOTE:

Venturi comes from the factory in the CLOSED position for use with Natural Gas and must not be adjusted.

Air restrictor comes from the factory in the OPEN position and is not to be adjusted.

Pilot Adjustment

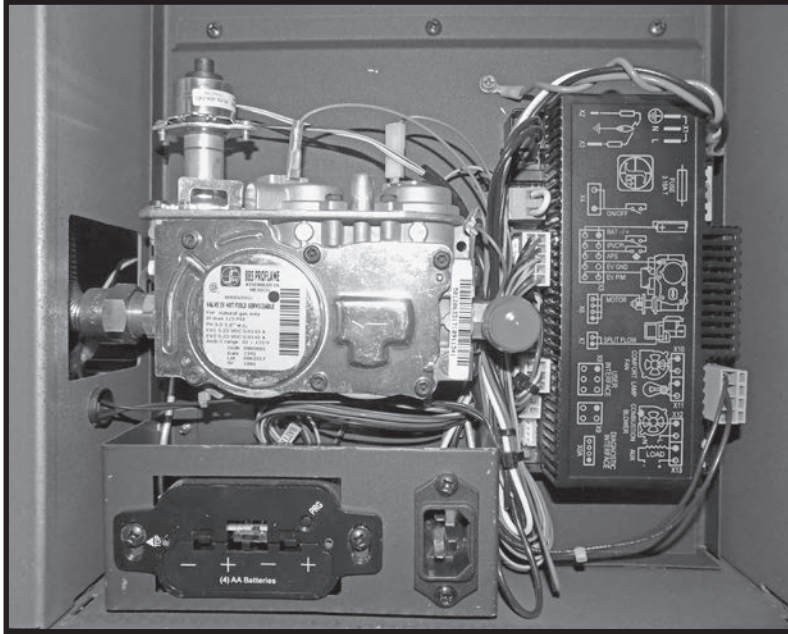

Figure 43: Valve & IFC module location.

Verify the pilot flame by turning the adjustment screw, using a flat-tip screwdriver, seen on the valve in Figure 4434.

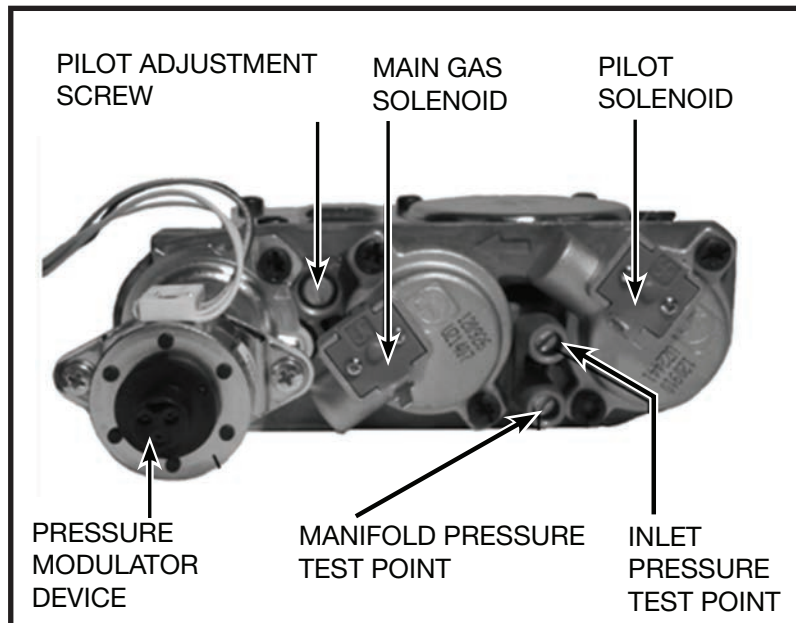

Figure 44: Gas control valve.

Comfort Fan Removal / Installation

Removal

1. Disconnect the power cord from the unit.
2. Remove 3 screws holding the side panel in place at the rear of the unit (Figure 49 on page 33)
3. Disconnect the power connections (Figure 45).
4. Remove the two (2) screws holding the fan in place (Figure 45) and remove the fan out of unit.

Installation

Installation is the reverse of removal

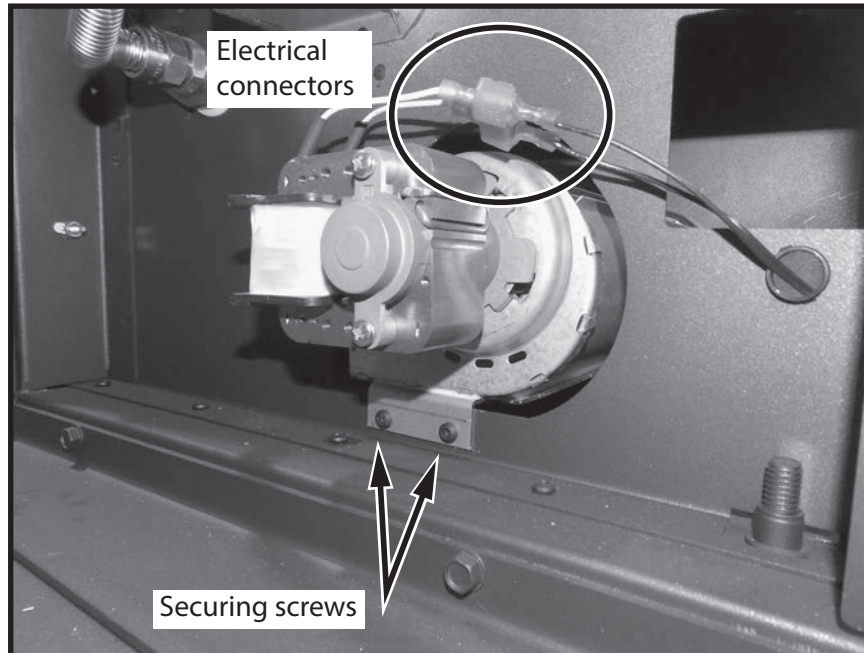

Figure 45: Blower fan connections.

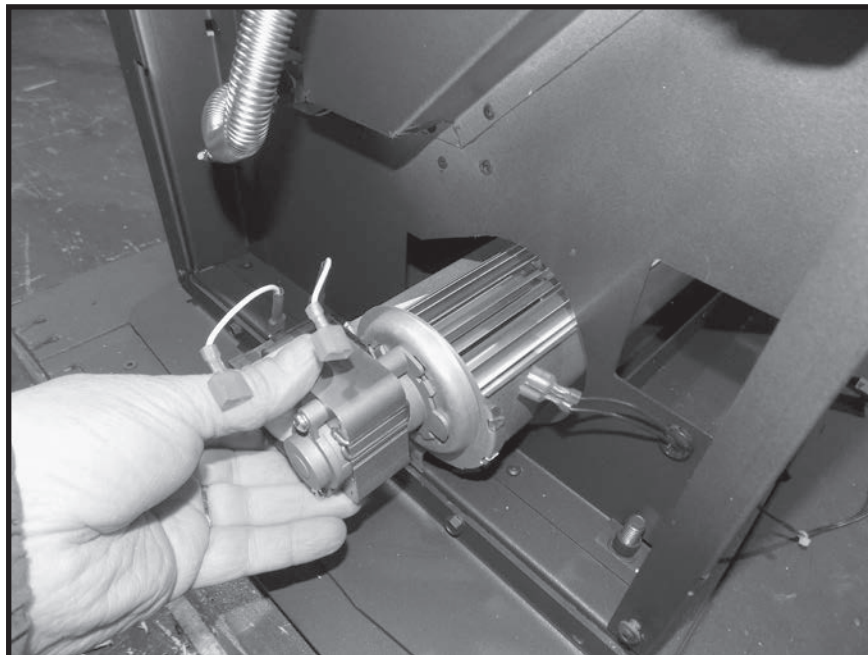

Figure 46: Removing blower fan.

Exterior Panel Removal/Installation



Figure 47: Mirage 18 front and side panels.



Figure 48: Removing mesh screen cover.



Figure 49: Side panel attachment points.

Removal

The Mirage 18 cladding consists of four panels; the right and left (as seen from the viewers' perspective), and an upper and lower panel inset with grills. To remove the panels for service reasons or to change to a different set of panels, begin by removing the mesh screen panel (Figure 48) so as not to accidentally damage the mesh screen. The mesh screen panel easily lifts off of four posts - two on either side of the glass door.

Remove the side panels first by removing the 3 screws that secure the side panels to the heater (Figure 49). Then push the panels toward the front of the stove. This will free the panels from the front positioning posts/screws (Figure 52 and Figure 53).



Figure 50: Mirage 18 side panels.

Top positioning screw/post for right hand panel.

Right hand securing screw for upper front panel

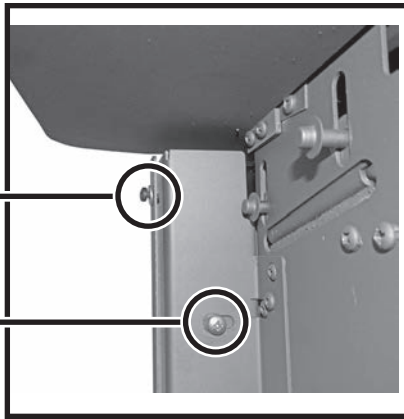

Figure 52: Upper attach points for side and upper panels.

Right hand securing screw for lower front panel

Bottom positioning screw/post for right hand panel.

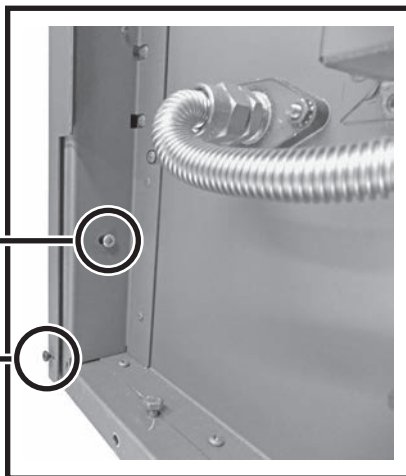

Figure 53: Lower attach points for side and lower panels.

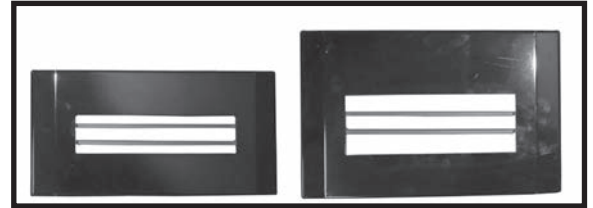

Figure 54: Mirage 18 upper and lower front panels.



Figure 55: Lower front panel and grill.



Figure 51: Mirage 18 with right side panel removed.

To remove the upper and lower panels - with the side panels off, remove the two screws on either side of each of the two panels (Figure 52 and Figure 53). Be careful to support the upper and lower panels as they are being removed because each panel has a grill inset within it (Figure 55). These grills are not fastened to the panels and so may fall during removal.

Installation

Installation of the panels is the reverse of removal. Take note that the upper panel is shorter than the lower panel (Figure 54). Also note that the grills of each panel are not pre-attached and therefore are a little more difficult to align while mounting.

Pilot Assembly Replacement

To access and remove the pilot assembly.

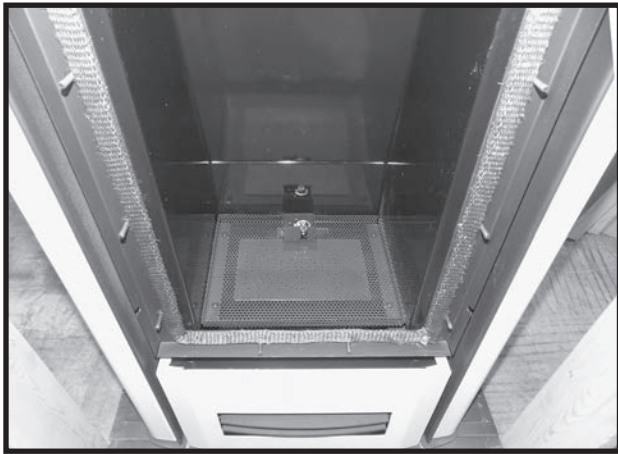

Figure 56: Empty firebox.



Figure 57: Burner tray removal.

1. Turn off the Mirage and allow it to cool down before proceeding.
2. At the rear of the Mirage, disconnect the power cord.
3. Shut the gas supply off at its source.
4. On the front side of the stove, remove the screen cover and glass door from the front of the Mirage. See "Door Removal / Installation" on page 28.
5. Remove media from firebox.
6. Remove the burner tray by removing four screws and extracting the tray as shown in Figure 57.
7. Remove interior panels as outlined in "Firebox Panel Removal / Installation" on page 24.

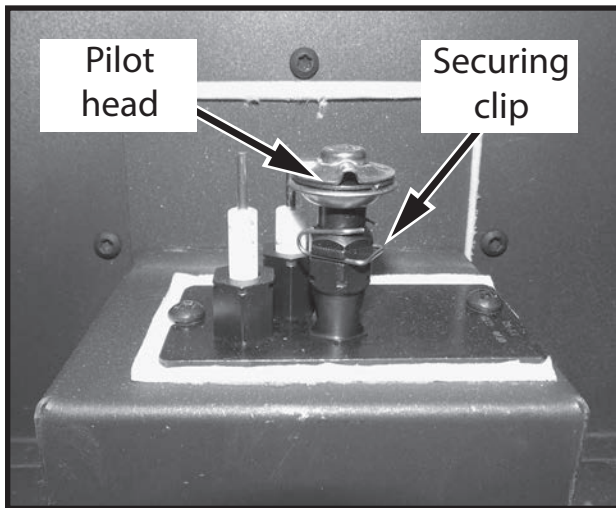

Figure 58: Pilot head and securing clip.

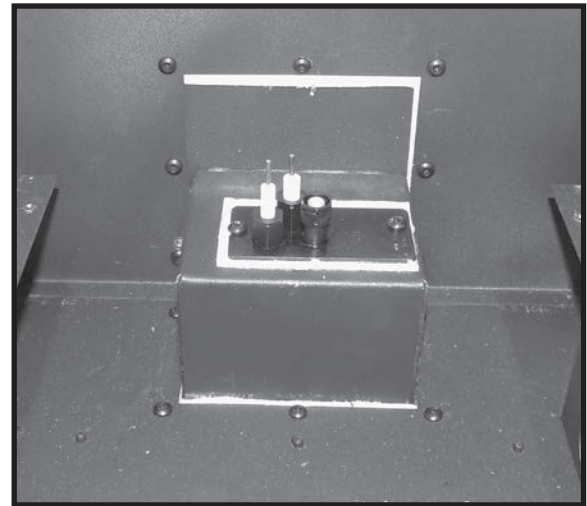

Figure 59: Control panel front side screws.

8. Remove the pilot head by taking the securing clip off and lifting the head off of its support (Figure 58). This will prevent damage while the the pilot control panel is being extracted through the rear of the unit.
9. Remove the two Philips screws securing the pilot head assembly to its support (Figure 59).
10. Remove all of the screws surrounding the support. These include screws on the floor in front of the support and on the wall behind the support (Figure 59).

At the rear of the appliance:

11. Disconnect the main gas supply line (Figure 60).
12. Remove the rear screen located on the lower portion of the Mirage by removing its three screws.
13. Disconnect the gas supply line to the gas valve (Figure 62). It is not necessary to disconnect the pilot gas line at this time since it will come out with the control panel once it's removed and can be removed at that time.
14. Remove connector X10 (comfort fan) from the control module (Figure 63).
15. Remove the four screws located at the top of the control panel as shown in Figure 64.
16. Remove the single screw located between the power receptacle and the control module (Figure 65).
17. The control panel (Figure 66) can now be extracted from the rear of the heater and serviced on a table top.

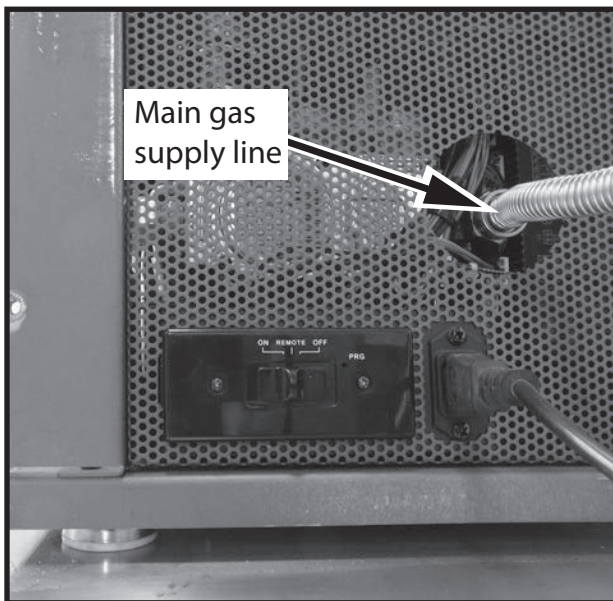

Figure 60: Removing the main gas supply line.

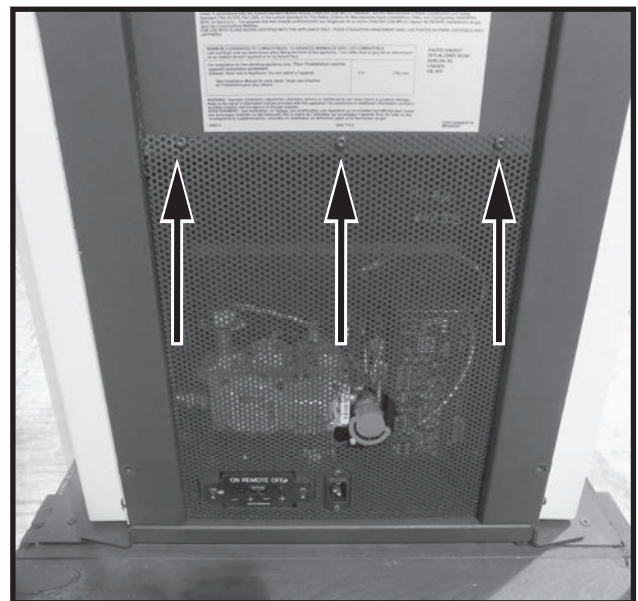

Figure 61: Rear screen removal.

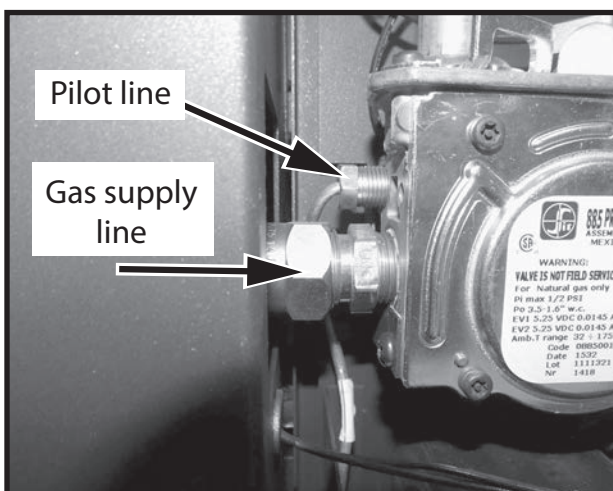

Figure 62: Gas line connections at gas valve.

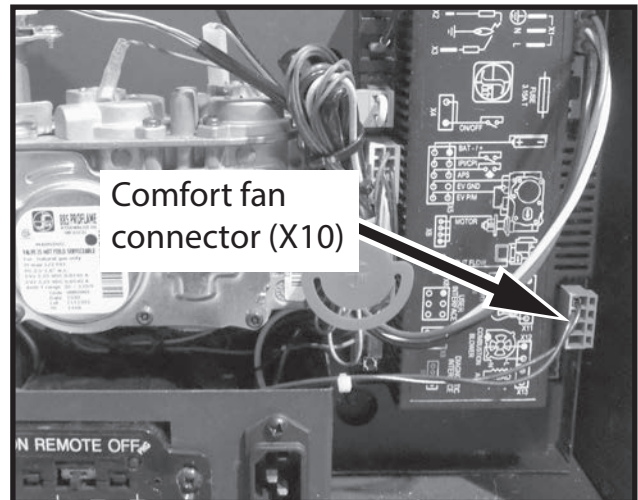

Figure 63: Comfort fan electrical connector.

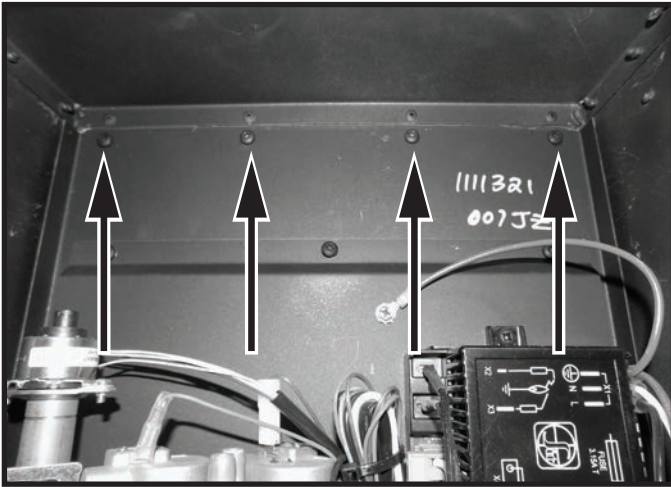

Figure 64: Control panel securing screws.

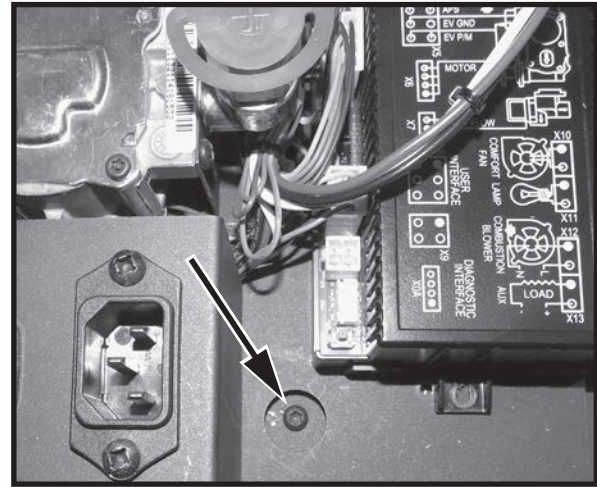

Figure 65: Remove lower screw.

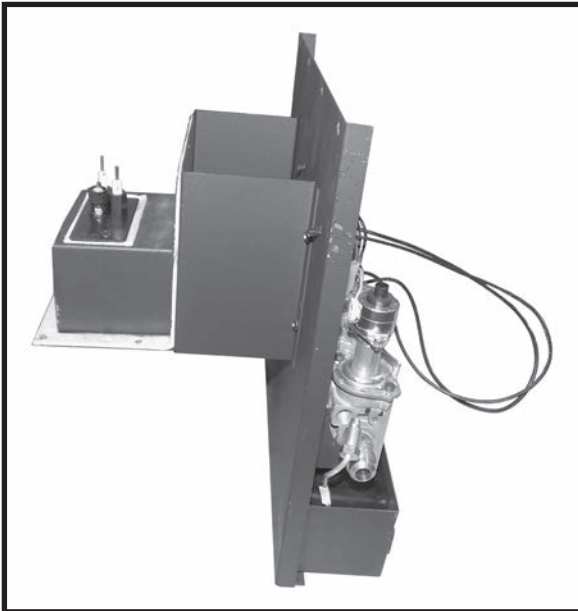

Figure 66: Control panel extracted from the unit.

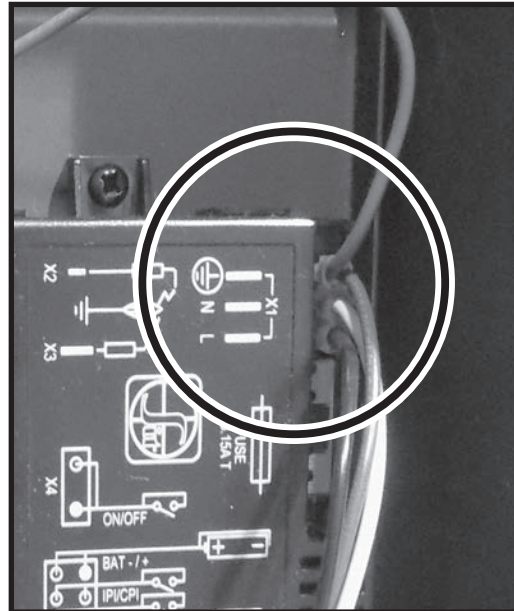

Figure 67: Line in connections.

Replacing the pilot assembly.

Extracting the pilot assembly requires that the control module be partially removed so that there is room to withdraw and reinsert the pilot assembly wires and gas line, otherwise there is not enough room to work with.

1. Release the control module by removing the two screws located at the top and the bottom of the control module. This will provide room to extract and reinsert the pilot wires (X2 & X3 on the control module) and pilot gas line through the square slot.
2. Disconnect the pilot gas line from the gas valve if not already removed.
3. Remove all of the connectors from the control module - including the ground wire, with the exception of X1 (Line in connection) as these wires are long enough to provide the needed room to move the control module aside.

4. Remove the pilot assembly by guiding the pilot wires and pilot gas line out through the opening between the gas valve and the control module, and the opening which the pilot head sits. Take note of how the pilot gas line is routed through the control panel as the new pilot assembly gas line will have to be routed the same way. See Figure 7060.
5. Before reassembling the components, examine the gaskets that are attached to the control panel (Figure 69) and replace if necessary.
6. Reassemble all components.

NOTE: Extreme care must be taken when routing the new gas line into place so that the gas line does not become crimped or twisted.



Figure 68: Square slot for insertion and removal of pilot assy.

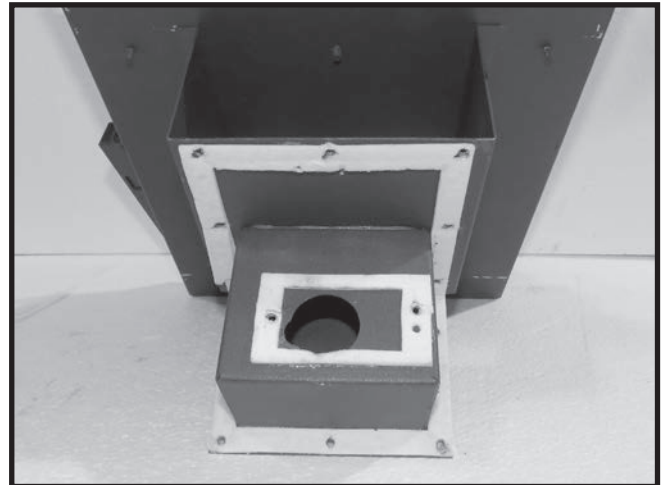

Figure 69: Pilot assembly removed showing gaskets.

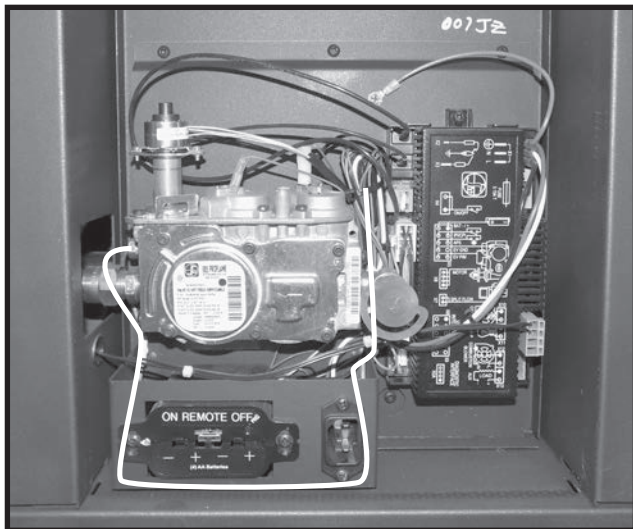

Figure 70: Gas line routing.

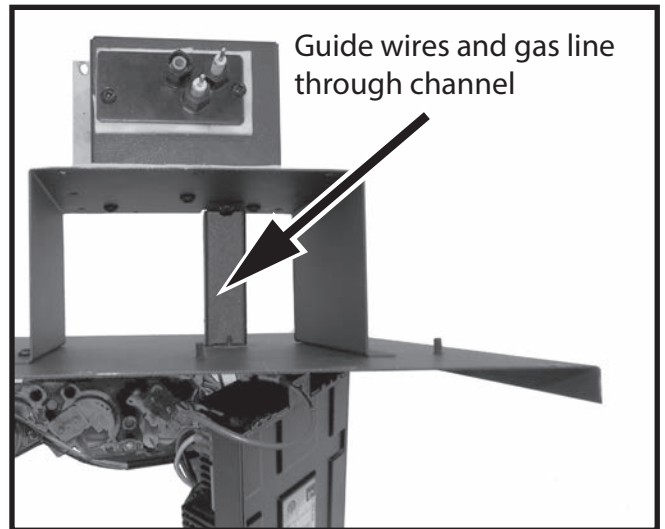

Figure 71: Control panel top view.

Propane Conversion

Note: The propane conversion kit is not included with the burner kit. The conversion kit is an option which must be ordered separately.

Before starting the conversion make sure to shut off the gas supply to the unit and allow stove to cool to room temperature.

To convert the gas stove from natural gas to propane, the (GASC.LP18KIT) kit is required. This kit comes with new pilot and burner orifice as well as a new pressure modulator for the valve.

To switch the pressure modulator, follow the instructions that are provided with the conversion kit.

To change the orifice you are required to remove the door, and side cladding on your right. Please refer to the appropriate sections of this manual and follow instructions on how to correctly remove the components.

After removing the side cladding you will have access to the burner orifices' mounting plate on right side of unit. To access the orifice, remove the two nuts securing the mounting plate and pull from side of unit (Figure 74) . The orifice can be removed using a 1/2" (12.7 mm) socket. Before installing the new orifice, Loctite 567 Thread Sealant needs to be applied to the threads of the new orifice to ensure a proper seal when installed.

To replace the pilot orifice or to clean the pilot itself, you will need to remove the pilot hood which is held in place by a spring. First remove the spring (Figure 73) and then remove the hood by pulling it up from the pilot bracket. To remove the existing orifice insert a 5/32" or 4mm Allen wrench into the hexagonal key-way of the orifice and rotate counter-clockwise until free. Insert the new orifice using the same Allen wrench and tighten it until a torque of 9 lbf in (1 Nm) is achieved. Replace the pilot hood by aligning the tab on the base of the hood with the slot in the side of the pilot journal, and push the hood down onto the pilot bracket. Replace the spring by pushing it onto its seat.

Before reinstalling the cladding, the venturi shutter will have to be adjusted to the correct opening - "Air Adjustment" on page 30 for correct adjustment of venturi.

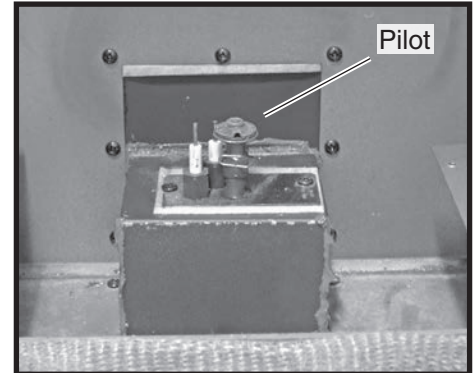

Figure 72: Mirage 18 Pilot.

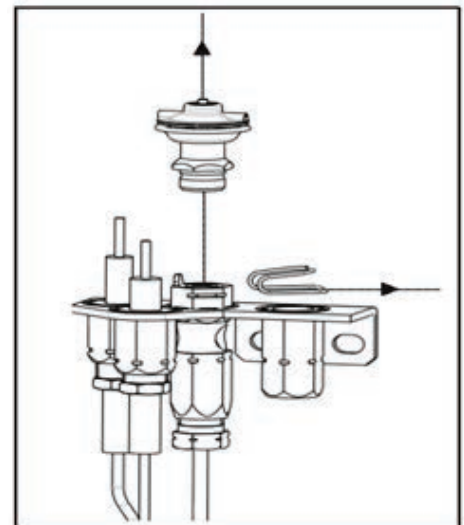

Figure 73: Pilot hood.

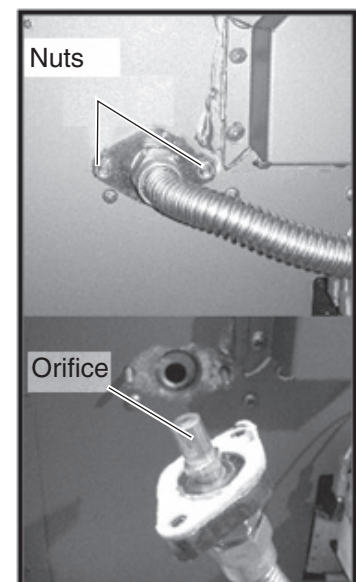

Figure 74: Orifice extraction.

Maintenance

CAUTION:

Turn off gas and electrical power supply (if applicable) and allow ample time for unit to cool before servicing appliance. It is recommended that the gas stove and its venting should be inspected at least once a year by a qualified service person.

Glass Door:

Warning: Do not operate gas stove with glass door removed, cracked or broken. Replacement of the glass door should be done by a licensed or qualified service person.

Do not strike or otherwise impact the glass in anyway that may cause it to break. If the glass becomes cracked or broken it must be replaced before using the fireplace. Replacement glass can be obtained from your nearest Pacific Energy™ dealer. The size required is 13" x 20 5/16" x 5mm (330.2 x 515.93 x 5 mm). Use ceramic glass only. **Do not substitute with any other type.**

To remove broken glass, remove door frame as noted in section, "Door Removal / Installation" on page 28. Unclip the glass retainer clips located at the top and sides of the glass door frame. Pull the top edge of the glass out of the frame first, then lift it up and out of the bottom edge.

Install the new piece of glass with the gasket into the frame so that the thicker bead of gasket faces the gas stove.

Re-install glass retaining clips.

Annual Inspection:

- a) Remove glass door and inspect the decorative burner media (such as logs, pebbles, glass etc) for soot build up. If excessive build up of soot is present, have a qualified service person inspect and adjust the unit for proper combustion. Clean the decorative media and use a brush or vacuum cleaner to clean the burner, paying close attention to the burner ports.
- b) Check the pilot system for proper flame size and operation. Clean pilot free of soot, dust or any other deposits.
- c) Check that the vent pipe and vent terminal are open and free from blockage or debris. If the venting is disassembled for cleaning, it must be properly assembled and re-sealed.
- d) Check glass panel gasket, replace if necessary. It is important that the glass seal be maintained in good condition.
- e) Check and replace batteries as needed.

Note: The appliance area must be kept clear and free from combustible materials, gasoline and other flammable vapours and liquids.

Periodically:

- a) Viewing glass may be cleaned as necessary with glass cleaner.
- b) Exterior finish may be cleaned with mild soap and water.

CAUTION:

Do not use abrasive cleaners on glass or any other part of the gas stove.

Do not clean glass when hot.

Replacement Parts

Description	SKU
1. Replacement Control Module	80002043
2. Replacement Gas Valve	80000194
3. Replacement Pilot Assembly	80000193
4. Replacement Remote Control.....	80002044
5. Replacement Complete Gas Tray.....	80002050
6. Replacement Blower Kit.....	80002045
7. Replacement Burner	80000308
8. Replacement Door Glass	80000216
9. Replacement Door Screen/Front Trim.....	80002051

Aesthetic Components

Exterior Porcelain Panels

Red Panels	80001879
Ivory Panels.....	80001878
Black Panels.....	80001689
Titanium Panels	80001690

Interior Porcelain Panels

Lower back	80002052
Upper back	80002053
Left Side	80002054
Right side	80002055

Optional Components

Driftwood Log set with pebbles	42160001
Black Glass	12160006
Amber Glass.....	GASC.15DE
Glass	GASC.15GLTW
Blue Glass	GASC.15GLPA
Propane Conversion Kit	12180009

Optional Flueing Component

Co-axial Adapter	80000268
------------------------	----------

Wiring Diagram

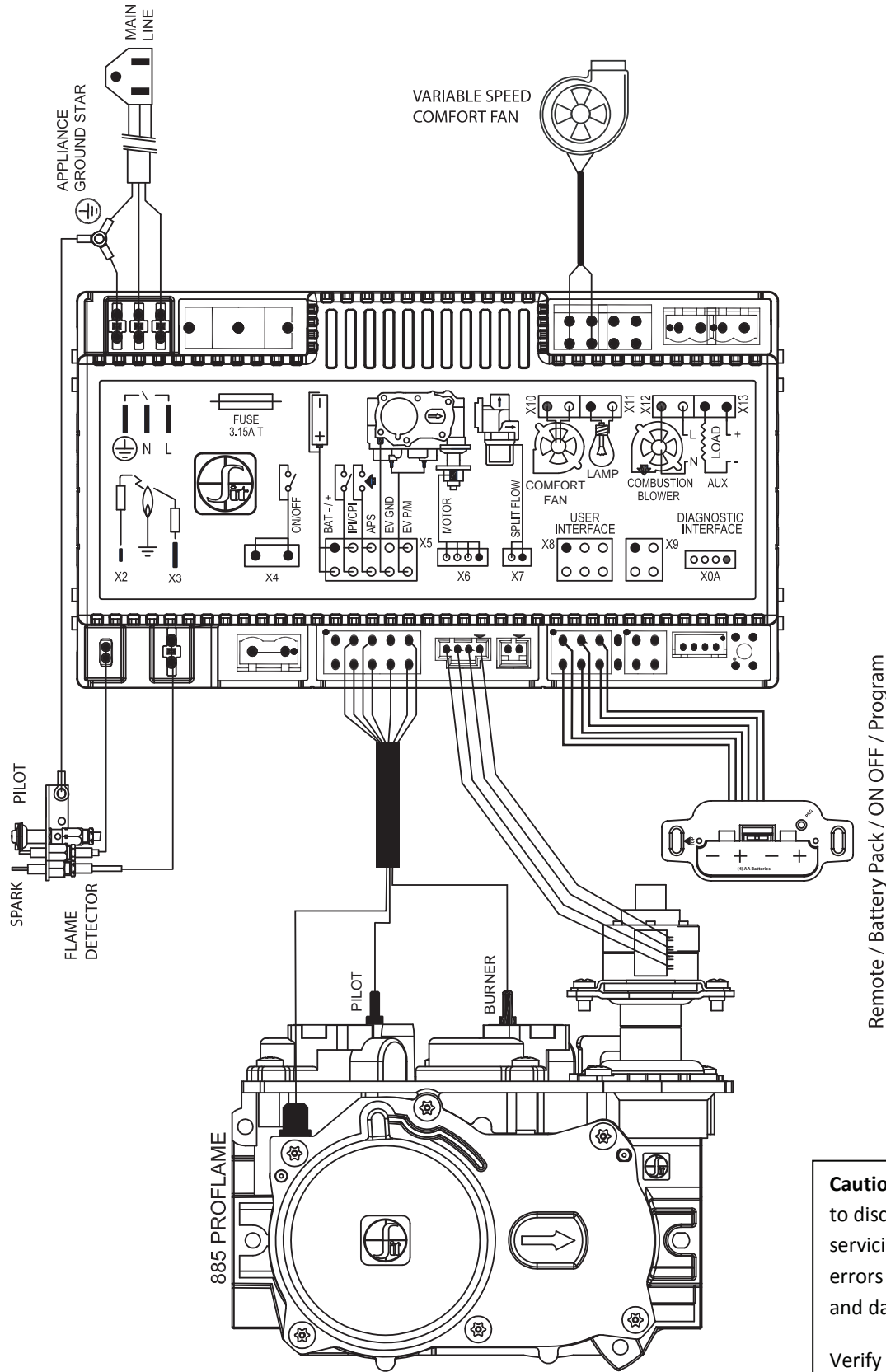

Remote / Battery Pack / ON OFF / Program

Caution: Label all wires prior to disconnection when servicing controls. Wiring errors can cause improper and dangerous operation.

Verify proper operation after servicing.

Figure 75: Electrical diagram for Mirage 18.

Rating Label



Gas Safety
Certified
AS/NZS 5263.1.3
SAI-400322



MODEL: MIRAGE 18

SERIES: **A**

MADE IN CANADA

Unit electrical rating: 240v, 50hz, 0.47A / 0.0373 kW
This appliance equipped for altitudes 0 - 1372 m

VENTED GAS FIREPLACE HEATER - NOT FOR USE WITH SOLID FUEL

AS/NZS 5263.0:2017-Gas Appliances; AS/NZS 5263.1.3:2016
Gas Space Heating Appliances.

Certified for Australia (NG and LP).
Certified for New Zealand (NG only).

LC- 318

This Appliance is Equipped For Use With:

NATURAL GAS LP-GAS

FOR USE WITH/:	NATURAL GAS	LP GAS
Inlet Pressure: (For the purpose of input adjustment)	1.13 kPa	2.75 kPa
Manifold Pressure:	.87 kPa	2.48 kPa
Orifice Size:	1.98 mm	1.25 mm
Nominal Gas Consumption MJ/hr (kW):	Max.: 18.99 MJ (5.2kw) Min.: 13.17 MJ (3.6kw)	Max.: 18.99 MJ (5.2kw) Min.: 14.77 MJ (3.9kw)

SUITABLE ONLY FOR INDOOR INSTALLATION

PACIFIC ENERGY
2975 ALLENBY ROAD
DUNCAN, BC
CANADA, V9L 6V8

THE GUARD IS FITTED TO THIS APPLIANCE TO REDUCE THE RISK OF FIRE OR INJURY FROM BURNS AND NO PART OF IT SHOULD BE PERMANENTLY REMOVED.

FOR THE PROTECTION OF YOUNG CHILDREN OR THE INFIRM, A SECONDARY GUARD IS REQUIRED.

FOR USE WITH GLASS DOORS CERTIFIED WITH THE APPLIANCE ONLY

DATE OF MANUFACTURE

MINIMUM CLEARANCES TO COMBUSTIBLES Left and Right side are determined when facing the front of the appliance.	
For Installation as free standing appliance only	
Sidewall / Back wall to Appliance	(102 mm)
Ceiling / Top of Appliance	(915 mm)
*See Installation Manual for more detail.	

JAN	FEB	MAR	APR	2018
MAY	JUN	JUL	AUG	2019
SEP	OCT	NOV	DEC	2020

WARNING: Improper installation, adjustment, alteration, service or maintenance can cause injury or property damage. Refer to the owner's information manual provided with this appliance. For assistance or additional information, consult a qualified installer, service agency or the gas supplier.

120118

50000093-00

MR18BODYA

© 2018 Copyright Pacific Energy Fireplace Products LTD

Reproduction, adaptation, or translation
without prior written permission is prohibited,
except as allowed under the copyright laws.

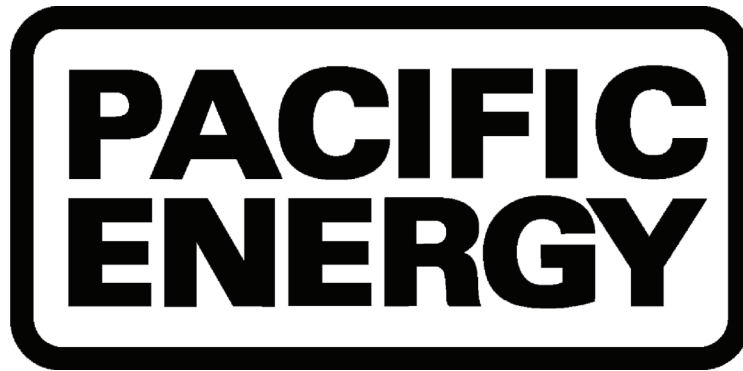

For technical support, please contact your retailer.

Pacific Energy Australia PTY LTD.

**Web site: www.pacificenergy.net
120 Victoria Street, North Geelong,
Victoria**